

PHASED ARRAY & CONVENTIONAL ULTRASONIC TRANSDUCERS

STANDARD PRODUCT CATALOG



- GENERAL-PURPOSE LINEAR
- WELD INSPECTION
- SMALL FOOTPRINT
- LOW-PROFILE
- TOFD
- CORROSION
- FLEXIBLE ARRAY
- WHEELARRAY™
- IMMERSION LINEAR
- CONTACT MEMBRANE
- TFM ARRAY
- MATRIX ARRAY
- DUAL MATRIX ARRAY
- HIGH-TEMP LINEAR
- HIGH-TEMP DUAL LINEAR
- CONVENTIONAL
- CUSTOM SOLUTIONS

TABLE OF CONTENTS

- 3 Why Choose Phased Array
- 4 Understanding Phased Array
- 5 Part Number Guidelines
- 6-7 General-Purpose Linear
- 8-9 Weld Inspection
- 10..... Small Footprint
- 11-12..... Low-Profile
- 13..... M15 Matrix Array
- 14..... TOFD
- 15..... Corrosion
- 16..... Flexible Array
- 17..... WheelArray™
- 18..... Immersion Linear
- 19..... Contact Membrane
- 20 TFM Array
- 21..... Matrix Array
- 22..... Dual Matrix Array
- 23 High-Temp Linear
- 24 High-Temp Dual Linear
- 25 Connectors, Splitters, & Adapters
- 27..... Conventional Part Number Guidelines
- 28 Contact
- 29 DFR
- 30 Pencil Probe
- 31-32 QS
- 33 MSWS
- 34 AWS
- 35-36 SWS
- 37-38..... DHT Series
- 39 ADP
- 40-41..... Thickness Gauging
- 42-43..... I2, I3, I4
- 44 IR
- 45 I1
- 46 Conventional Accessories
- 47 Appendix
- 48 Custom Solutions Capabilities
- 49-50 One-Stop PAUT Shop

Download



Stay up to date with
the latest version!





ELEVATING INDUSTRY STANDARDS WITH EDDYFI TECHNOLOGIES

YOUR COMPLETE PHASED ARRAY ULTRASONIC TESTING SOLUTION PROVIDER

Eddyfi Technologies is committed to revolutionizing non-destructive testing (NDT) across various industries like aerospace, oil and gas, mining, and power generation. Our focus is on providing a comprehensive phased array ultrasonic testing (PAUT) solution, tailored to precise application needs, ensuring the safety and integrity of critical components and assets. Our range of cutting-edge instruments, software, scanners, crawlers, and advanced probes, collectively form a dynamic inspection solution. With a commitment to transforming NDT practices, our specialized phased array ultrasonic transducers are meticulously crafted to address specific application requirements and emphasize the safety and integrity of high-value assets everywhere.

WHY CHOOSE PHASED ARRAY TECHNOLOGY

Phased array technology significantly enhances inspection productivity and the Probability of Detection (PoD) for anomalies within the test part. It enables precise 2D or 3D imaging, aiding informed decisions about a component's fitness-for-service. Our technology boasts:

LINEAR SCANNING

The beam is electronically translated by alternately firing a given number of elements of a phased array transducer. Only one angle is transmitted but is introduced multiple times throughout the length of the array.

BEAM STEERING

By alternating the time sequence of the pulses, the direction of the transmitted beam can be varied to any desired scan angle. This allows for multiple angle inspections, using a single transducer.

BEAM FOCUSING

The beam is electronically focused by applying symmetrical delay laws to the different elements of a transducer. This technique can be combined with beam steering to produce both angled and focused beams.

UNDERSTANDING PHASED ARRAY TRANSDUCERS

Phased array transducers consist of multiple piezoelectric elements that can be individually pulsed at distinct times. This unique capability accurately focuses or steers the ultrasonic beam in specific directions, enabling meticulous production of varying angles, focal distances, and focal spot sizes of beams.

PRECISE PROBES FOR SPECIFIC SCENARIOS

Our technical expertise allows us to offer custom probes tailored for specific applications, including assessing complex composite materials in the aerospace sector, addressing high-temperature hydrogen attack, or other industry challenges. Partner with us for a complete phased array ultrasonic testing solution engineered with unmatched speed and precision.

SEAMLESS QUOTING VIA EDDYFI'S ESTORE

Elevate your NDT capabilities instantly through our user-friendly Eddyfi eStore. Scan the QR code or visit store.eddyfi.com for swift, personalized quotes and secure the perfect phased array ultrasonic testing solution for your unique requirements.

Join the league of industry professionals who have revolutionized their NDT approach with Eddyfi Technologies' complete PAUT package to stay Beyond Current.



ARRAY ACRONYM GUIDELINES

5L128-A12-38.4X10-2.5-IPEX-xx

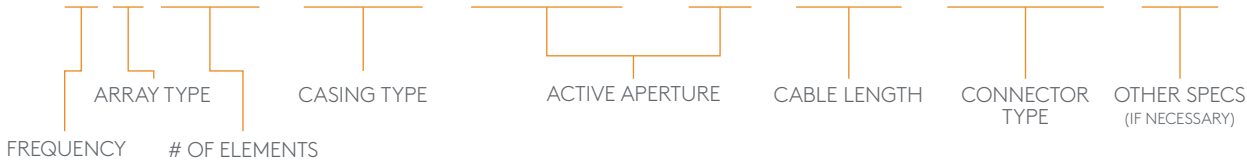

FREQUENCY

In MHz

ARRAY TYPE

L = Linear
 AN = Annular
 M = Matrix
 DL = Dual Linear
 DM = Dual Matrix
 CC = Concave in azimuth
 (with radius in mm)

OF ELEMENTS

#Elements - Primary Axis
 #Elements - Secondary Axis

CASING TYPE

A = Angle Beam with external wedge
 NW = Near-Wall
 AWS - AWS Inspection
 BS = Beam Straight
 HW = High-Wall
 I = Immersion
 CS = Corrosion Small
 CL = Corrosion Large
 FLEX = Flexible

ACTIVE APERTURE

In mm (Primary Axis)
 = (#Elements*Pitch)
 In mm (Secondary Axis)
 = (#Elements*Pitch)

CABLE LENGTH

In meters

CONNECTOR TYPE

IPEX = IPEX Easy-Latch
 ZPAC = Zetec Phased Array Connector
 HYP = Hypertronics
 SCRW = IPEX with screws

OTHER SPECS

If necessary, may include:
 Cable Type (BRAID; etc...)
 Customization
 etc...

ARRAY WEDGE ACRONYM GUIDELINES

WSA31-55S-AOD2.25-IHC-xx



WEDGE TYPE

WS + ARRAY CASING

REFRACTED ANGLE

0 = 0°
 55 = 55°
 60 = 60°

WAVE TYPE

S = Shear Wave
 L = Longitudinal Wave

CURVATURE TYPE

FLAT = Flat Surface
 AOD = Axial Outside Diameter (circumferential scan)
 COD = Circumferential Outside Diameter (Axial Scan)

OPTIONS

IH = Integral Irrigation & Scanner Holes
 IHC = Integral Irrigation, Scanner Holes, & Carbide Wear Pins
 IHC RING

OTHER SPECS

If Necessary

GENERAL-PURPOSE LINEAR

General-purpose linear arrays are versatile probes that optimize a wide range of applications, including weld inspection, tube and pipe inspection, turbine blades, rails, pressure vessels, and many more. Varying in frequency, number of elements, and element pitch and elevation, the wide variety available provides many options when choosing an array for your application. Custom options are available upon request.

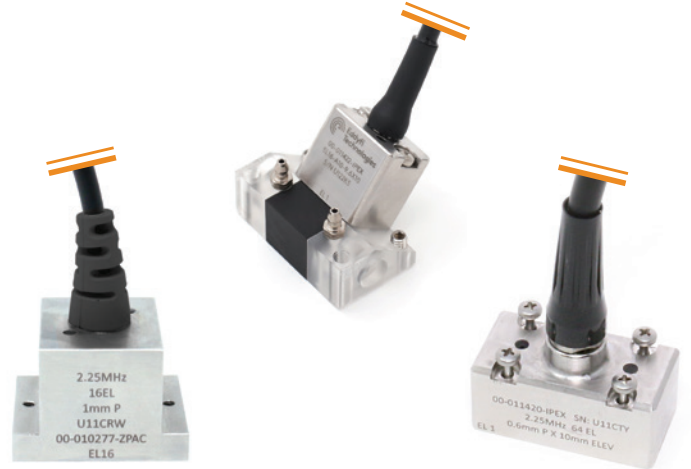

PHASED ARRAYS

CASE	PART NUMBER	FREQUENCY	ELEMENTS	APERTURE		PITCH		ELEVATION		CABLE LENGTH
A1	2.25L16-A1-12X12-2.5-IPEX	2.25	16	0.47	12	0.030	0.75	0.47	12	2.5M (8.2 ft.)
	5L16-A1-9.6X10-2.5-IPEX	5	16	0.38	9.6	0.024	0.60	0.39	10	2.5M (8.2 ft.)
	10L32-A1-10X7-2.5-IPEX	10	32	0.39	10	0.012	0.31	0.28	7	2.5M (8.2 ft.)
	2.25L8-A10-9.6X10-2.5-IPEX	2.25	8	0.38	9.6	0.047	1.20	0.39	10	2.5M (8.2 ft.)
A10	3.5L8-A10-9.6X10-2.5-IPEX	3.5	8	0.38	9.6	0.047	1.20	0.39	10	2.5M (8.2 ft.)
	5L16-A10-9.6X10-2.5-IPEX	5	16	0.38	9.6	0.024	0.60	0.39	10	2.5M (8.2 ft.)
	5L32-A10-9.6X10-2.5-IPEX	5	32	0.38	9.6	0.012	0.30	0.39	10	2.5M (8.2 ft.)
	7.5L32-A10-9.6X10-2.5-IPEX	7.5	32	0.38	9.6	0.012	0.30	0.39	10	2.5M (8.2 ft.)
A11	10L32-A10-10X7-2.5-IPEX	10	32	0.39	10	0.012	0.31	0.28	7	2.5M (8.2 ft.)
	2.25L32-A11-19.2X10-2.5-IPEX	2.25	32	0.75	19.2	0.024	0.60	0.39	10	3.0M (9.2 ft.)
	5L16-A11-16X10-2.5-IPEX	5	16	0.63	16	0.040	1.00	0.39	10	3.0M (9.2 ft.)
	5L32-A11-19.2X10-2.5-IPEX	5	32	0.75	19.2	0.024	0.60	0.39	10	2.5M (8.2 ft.)
	5L64-A11-19.2X10-2.5-IPEX	5	64	0.75	19.2	0.012	0.30	0.39	10	2.5M (8.2 ft.)
	10L64-A11-19.2X10-2.5-IPEX	10	64	0.75	19.2	0.012	0.30	0.39	10	2.5M (8.2 ft.)
A12	15L64-A11-19.2X10-2.5-IPEX	15	64	0.75	19.2	0.012	0.30	0.39	10	2.5M (8.2 ft.)
	2.25L64-A12-48X10-2.5-IPEX	2.25	64	1.89	48	0.030	0.75	0.39	10	2.5M (8.2 ft.)
	2.25L64-A12-38.4X10-2.5-IPEX	2.25	64	1.51	38.4	0.024	0.60	0.39	10	2.5M (8.2 ft.)
	3.5L64-A12-38.4X10-2.5-IPEX	3.5	64	1.51	38.4	0.024	0.60	0.39	10	2.5M (8.2 ft.)
	5L64-A12-38.4X10-2.5-IPEX	5	64	1.51	38.4	0.024	0.60	0.39	10	2.5M (8.2 ft.)
	5L128-A12-38.4X10-2.5-IPEX	5	128	1.51	38.4	0.012	0.30	0.39	10	2.5M (8.2 ft.)
A2	7.5L64-A12-38.4X10-2.5-IPEX	7.5	64	1.51	38.4	0.024	0.60	0.39	10	2.5M (8.2 ft.)
	10L64-A12-38.4X10-2.5-IPEX	10	64	1.51	38.4	0.024	0.60	0.39	10	2.5M (8.2 ft.)
	2.25L64-A2-48X12-2.5-IPEX	2.25	64	1.89	48	0.024	0.60	0.47	12	2.5M (8.2 ft.)
	2.25L64-A2-48X12-3.5-IPEX	2.25	64	1.89	48	0.030	0.75	0.47	12	3.5M (9.8 ft.)
A3	5L64-A2-38.4X10-2.5-IPEX	5	64	1.51	38.4	0.024	0.60	0.39	10	2.5M (8.2 ft.)
	10L64-A2-38.4X7-2.5-IPEX	10	64	1.51	38.4	0.024	0.60	0.28	7	2.5M (8.2 ft.)
A3	3.5L16-A3-25.6X16-3.5-IPEX	3.5	16	1.00	25.6	0.063	1.60	0.63	16	3.5M (9.8 ft.)
	5L16-A3-19.2X12-2.5-IPEX	5	16	0.75	19.2	0.047	1.20	0.47	12	2.5M (8.2 ft.)

Other cable lengths available upon request.

| in. | mm | in. | mm | in. | mm |

CASE DIMENSIONS

CASE TYPE	CASE DIMENSIONS					
	LENGTH		WIDTH		HEIGHT	
A1	0.67 in.	17 mm	1.09 in.	27.7 mm	0.99 in.	25.1 mm
A2	2.09 in.	53.1 mm	1.14 in.	29 mm	1.36 in.	34.5 mm
A3	1.42 in.	36.1 mm	1.35 in.	34.3 mm	1.0 in.	25.4 mm
A10	0.91 in.	23.1 mm	0.63 in.	16 mm	0.79 in.	20.1 mm
A11	0.98 in.	24.9 mm	0.91 in.	23.1 mm	0.79 in.	20.1 mm
A12	1.77 in.	45 mm	0.91 in.	23.1 mm	0.79 in.	20.1 mm

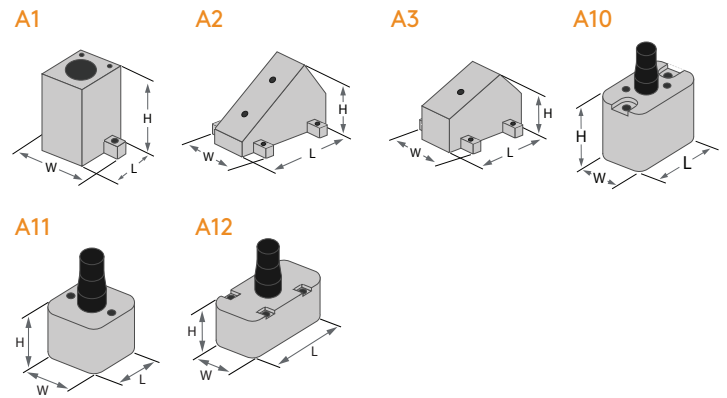

WEDGES

WEDGE TYPE	DESCRIPTION	PART NUMBER	DIMENSIONS					
			LENGTH		WIDTH		HEIGHT	
A1	Standard wedge for A1 phased array probe - Designed for linear scanning at 0 degree using LW - 0deg LW nominal angle - 20mm delay	WSA1-0L-FLAT-20mm	1.14 in.	29 mm	1.18 in.	30 mm	0.79 in.	20 mm
	Standard wedge for A1 phased array probe - Designed for azimuthal scanning from 40 to 70 degree using SW - 60deg SW nominal angle - Irrigation, probe holder fixtures & carbides	WSA1-60S-FLAT-IHC	1.20 in.	30.5 mm	1.58 in.	40.1 mm	0.64 in.	16.3 mm
A2	Standard wedge for A2 phased array probe - Designed for linear scanning at 0 degree using LW - 0deg LW nominal angle - 20mm delay	WSA2-0L-FLAT-20mm	2.56 in.	65 mm	1.18 in.	30 mm	0.79 in.	20 mm
	Standard wedge for A2 phased array probe - Designed for azimuthal scanning from 40 to 70 degree using SW - 55deg SW nominal angle - Irrigation, probe holder fixtures & carbides	WSA2-55S-FLAT-IHC	2.70 in.	68.6 mm	1.58 in.	40.1 mm	1.70 in.	43.2 mm
A10	Standard wedge for A10 phased array probe - Designed for linear scanning at 0 degree using LW - 0deg LW nominal angle - 20mm delay	WSA10-0L-FLAT-20mm	0.98 in.	24.9 mm	0.91 in.	23.1 mm	0.79 in.	20 mm
	Standard wedge for A10 phased array probe - Designed for azimuthal scanning from 40 to 70 degree using SW - 55deg SW nominal angle	WSA10-55S-FLAT	0.91 in.	23.1 mm	0.91 in.	23.1 mm	0.56 in.	16.5 mm
	Standard wedge for A10 phased array probe - Designed for azimuthal scanning from 40 to 70 degree using SW - 55deg SW nominal angle - Irrigation, probe holder fixtures & carbides	WSA10-55S-FLAT-IHC	1.21 in.	30.7 mm	1.56 in.	39.6 mm	0.56 in.	14.2 mm
	IHC Ring, ported wedge ring with wear pins	WSA10---IHC RING*	1.21 in.	30.7 mm	1.56 in.	39.6 mm	0.56 in.	14.2 mm
A11	Standard wedge for A11 phased array probe - Designed for linear scanning at 0 degree using LW - 0deg LW nominal angle - 20mm delay	WSA11-0L-FLAT-20mm	1.38 in.	35.1 mm	0.91 in.	23.1 mm	0.91 in.	23.1 mm
	Standard wedge for A11 phased array probe - Designed for azimuthal scanning from 40 to 70 degree using SW - 55deg SW nominal angle	WSA11-55S-FLAT	1.63 in.	41.4 mm	0.91 in.	23.1 mm	1.13 in.	28.7 mm
	Standard wedge for A11 phased array probe - Designed for azimuthal scanning from 40 to 70 degree using SW - 55deg SW nominal angle - Irrigation, probe holder fixtures, & carbides	WSA11-55S-FLAT-IHC	1.81 in.	46 mm	1.56 in.	39.6 mm	1.13 in.	28.7 mm
	IHC Ring, ported wedge ring with wear pins	WSA11---IHC RING*	1.81 in.	46 mm	1.56 in.	39.6 mm	1.13 in.	28.7 mm
A12	Standard wedge for A12 phased array probe - Designed for linear scanning at 0 degree using LW - 0deg LW nominal angle - 20mm delay	WSA12-0L-FLAT-20mm	2.28 in.	57.9 mm	0.91 in.	23.1 mm	0.79 in.	20 mm
	Standard wedge for A12 phased array probe - Designed for azimuthal scanning from 40 to 70 degree using SW - 55deg SW nominal angle	WSA12-55S-FLAT	2.88 in.	73.2 mm	0.91 in.	23.1 mm	1.76 in.	44.7 mm
	Standard wedge for A12 phased array probe - Designed for azimuthal scanning from 40 to 70 degree using SW - 55deg SW nominal angle - Irrigation, probe holder fixtures & carbides	WSA12-55S-FLAT-IHC	2.88 in.	73.2 mm	1.59 in.	40.4 mm	1.78 in.	45.2 mm
	IHC Ring, ported wedge ring with wear pins	WSA12---IHC RING*	2.88 in.	73.2 mm	1.59 in.	40.4 mm	1.78 in.	45.2 mm

Contoured wedges available upon request.

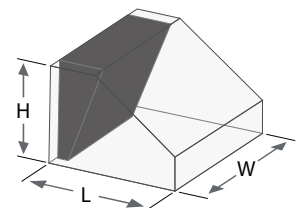

WELD INSPECTION

Weld inspection arrays paired with the right phased array wedge are perfect for conducting inspections on various weld, plate, and forging applications. A selection of options for arrays and wedges offers the ability to meet and optimize inspection requirements. Custom array and wedge options are available upon request.

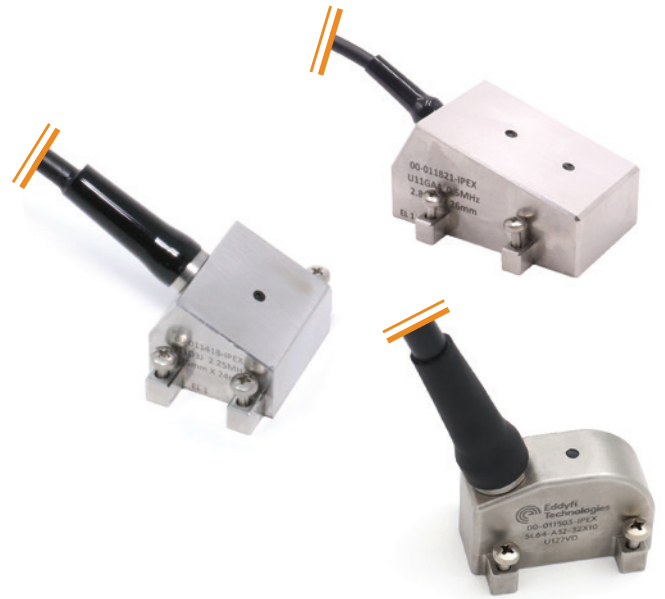

PHASED ARRAYS

CASE	PART NUMBER	FREQUENCY	ELEMENTS	APERTURE		PITCH		ELEVATION		CABLE LENGTH
A14	5L60-A14-60X10-2.5-IPEX	5	60	2.36	60	0.040	1.00	0.38	10	2.5M (8.2 ft.)
	7.5L60-A14-60X10-2.5-IPEX	7.5	60	2.36	60	0.040	1.00	0.38	10	2.5M (8.2 ft.)
PWZ1	2.25L60-PWZ1-60X10-2.5-IPEX	2.25	60	2.36	60	0.040	1.00	0.38	10	2.5M (8.2 ft.)
	5L60-PWZ1-60X10-2.5-IPEX	5	60	2.36	60	0.040	1.00	0.38	10	2.5M (8.2 ft.)
A4	0.5L16-A4-44.8X26-5-IPEX	0.5	16	1.76	44.8	0.110	2.80	1.02	26	5M (16.4 ft.)
	1.5L16-A4-44.8X26-2.5-IPEX	1.5	16	1.76	44.8	0.110	2.80	1.02	26	2.5M (8.2 ft.)
A5	2.25L16-A4-32X32-2.5-IPEX	2.25	16	1.25	32	0.080	2.00	1.26	32	2.5M (8.2 ft.)
	2.25L32-A5-24X24-2.5-IPEX	2.25	32	0.94	24	0.030	0.75	0.94	24	2.5M (8.2 ft.)
A31	5L32-A5-19.2X20-2.5-IPEX	5	32	0.75	19.2	0.024	0.60	0.76	20	2.5M (8.2 ft.)
	5L32-A31-19.2X10-2.5-IPEX	5	32	0.75	19.2	0.024	0.60	0.39	10	2.5M (8.2 ft.)
A32	7.5L32-A31-19.2X10-2.5-IPEX	7.5	32	0.75	19.2	0.024	0.60	0.39	10	2.5M (8.2 ft.)
	10L32-A31-19.2X10-2.5-IPEX	10	32	0.75	19.2	0.024	0.60	0.39	10	2.5M (8.2 ft.)
A32	5L32-A32-32X10-2.5-IPEX	5	32	1.25	32	0.040	1.00	0.39	10	2.5M (8.2 ft.)
	5L64-A32-32X10-2.5-IPEX	5	64	1.25	32	0.020	0.50	0.39	10	2.5M (8.2 ft.)
AWS	10L64-A32-32X10-2.5-IPEX	10	64	1.25	32	0.020	0.50	0.39	10	2.5M (8.2 ft.)
	2.25L16-AWS-16X16-2.5-IPEX	2.25	16	0.63	16	0.040	1.00	0.63	16	2.5M (8.2 ft.)

Other cable lengths available upon request.

| in. | mm | in. | mm | in. | mm |

CASE DIMENSIONS

CASE TYPE	CASE DIMENSIONS					
	LENGTH		WIDTH		HEIGHT	
A4	2.24 in.	56.9 mm	1.81 in.	46 mm	1.18 in.	30 mm
A5	1.14 in.	29 mm	1.69 in.	42.9 mm	0.94 in.	23.9 mm
AWS	1.26 in.	32 mm	0.80 in.	20.3 mm	0.75 in.	19 mm
A31	1.20 in.	30.5 mm	1.10 in.	27.9 mm	0.98 in.	24.9 mm
A32	1.58 in.	40.1 mm	1.10 in.	27.9 mm	1.0 in.	25.4 mm
A14	2.67 in.	67.8 mm	0.91 in.	23.1 mm	0.79 in.	9.9 mm
PWZ1	2.67 in.	67.8 mm	1.02 in.	25.9 mm	1.19 in.	30.2 mm

A4

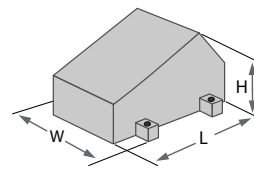

A5

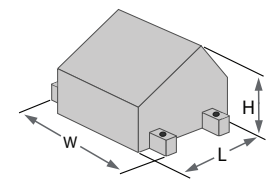

AWS

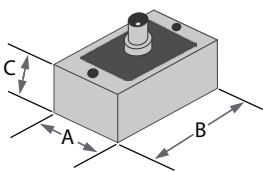

A31

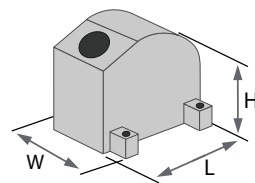

A32

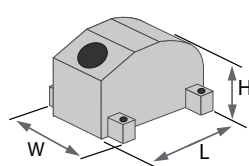

A14

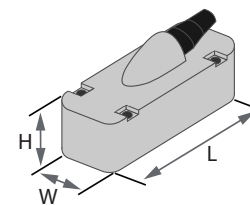

PWZ1

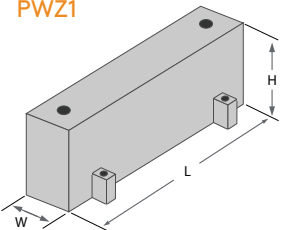

WEDGES

WEDGE TYPE	DESCRIPTION	PART NUMBER	DIMENSIONS		
			LENGTH	WIDTH	HEIGHT
A4	Standard wedge for A4 phased array probe - Designed for azimuthal scanning from 40 to 70 degree using SW - 55deg SW nominal angle - Irrigation, probe holder fixtures	WSA4-55S-FLAT-IH	3.39 in. 86.1 mm	1.85 in. 47 mm	1.77 in. 45 mm
A5	Standard wedge for A5 phased array probe - Designed for azimuthal scanning from 40 to 70 degree using SW - 55deg SW nominal angle - Irrigation, probe holder fixtures	WSA5-55S-FLAT-IH	1.56 in. 39.6 mm	1.71 in. 43.4 mm	0.63 in. 16 mm
A31	Standard wedge for A31 phased array probe - Designed for azimuthal scanning from 40 to 70 degree using SW - 55deg SW nominal angle - Irrigation, probe holder fixtures	WSA31-55S-FLAT-IH	1.91 in. 48.5 mm	1.18 in. 30 mm	1.26 in. 32 mm
	Standard wedge for A31 phased array probe - Designed for azimuthal scanning from 40 to 70 degree using SW - 55deg SW nominal angle - Irrigation, probe holder fixtures & carbides	WSA31-55S-FLAT-IHC	1.91 in. 48.5 mm	1.58 in. 40.1 mm	1.27 in. 32.3 mm
A32	Standard wedge for A32 phased array probe - Designed for azimuthal scanning from 40 to 70 degree using SW - 55deg SW nominal angle - Irrigation, probe holder fixtures	WSA32-55S-FLAT-IH	2.42 in. 61.5 mm	1.18 in. 30 mm	1.26 in. 32 mm
	Standard wedge for A32 phased array probe - Designed for azimuthal scanning from 40 to 70 degree using SW - 55deg SW nominal angle - Irrigation, probe holder fixtures & carbides	WSA32-55S-FLAT-IHC	2.42 in. 61.5 mm	1.58 in. 40.1 mm	1.30 in. 33 mm
A14	Standard wedge for A14 phased array probe - Designed for azimuthal scanning from 40 to 70 degree using SW - 55deg SW nominal angle	WSA14-55S-FLAT	Contact for dimensions		
	IHC Ring, ported wedge ring with wear pins	WSA14--IHC RING	Contact for dimensions		
PWZ1	Standard wedge for PWZ1 phased array probe - Designed for azimuthal scanning from 35 to 70 degree using SW - 50deg SW nominal angle - Irrigation, probe holders fixtures & carbides	WSPWZ1-50S-FLAT-IHC	3.23 in. 82 mm	1.5 in. 38.1 mm	1.73 in. 43.9 mm

Contoured wedges available upon request.

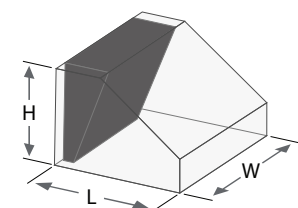

SMALL FOOTPRINT

Small footprint arrays are designed with small contact areas for inspections in tight or confined spaces. They can be used for a large variety of inspections, including welds, tubes and pipes, aircraft components, tanks and vessels, and more. Customizations to arrays and wedges can be specially ordered to further optimize your inspection requirements.

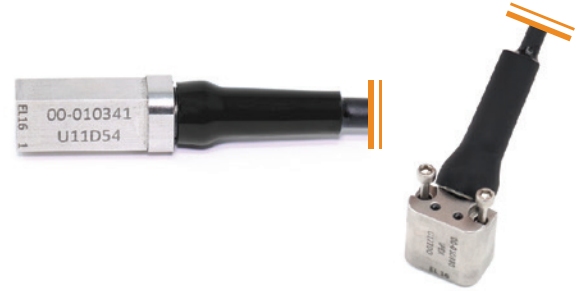

PHASED ARRAYS

CASE	PART NUMBER	FREQUENCY	ELEMENTS	APERTURE		PITCH		ELEVATION		CABLE LENGTH
0.25" MSWS	3.5L16-0.25MSWS-6.4X6.25-2.5-IPEX	3.5	16	0.25	6.4	0.016	0.40	0.25	6.25	2.5M (8.2 ft.)
	5L16-0.25MSWS-6.4X6.25-2.5-IPEX	5	16	0.25	6.4	0.016	0.40	0.25	6.25	2.5M (8.2 ft.)
	7.5L16-0.25MSWS-6.4X6.25-2.5-IPEX	7.5	16	0.25	6.4	0.016	0.40	0.25	6.25	2.5M (8.2 ft.)
	10L16-0.25MSWS-6.4X6.25-2.5-IPEX	10	16	0.25	6.4	0.016	0.40	0.25	6.25	2.5M (8.2 ft.)
0.5" MSWS	2.25L32-0.5MSWS-12.8X12.7-2.5-IPEX	2.25	32	0.50	12.8	0.016	0.40	0.50	12.7	2.5M (8.2 ft.)
	3.5L32-0.5MSWS-12.8X12.7-2.5-IPEX	3.5	32	0.50	12.8	0.016	0.40	0.50	12.7	2.5M (8.2 ft.)
	5L32-0.5MSWS-12.8X12.7-2.5-IPEX	5	32	0.50	12.8	0.016	0.40	0.50	12.7	2.5M (8.2 ft.)
A0	5L16-A0-6.4X6.25-2.5-IPEX	5	16	0.25	6.4	0.016	0.40	0.25	6.25	2.5M (8.2 ft.)
	10L16-A0-6.4X6.4-2.5-IPEX	10	16	0.25	6.4	0.016	0.40	0.25	6.4	2.5M (8.2 ft.)
A00	10L16-A00-5X5-2.5-IPEX	10	16	0.20	5	0.012	0.31	0.20	5	2.5M (8.2 ft.)

Other cable lengths available upon request.

| in. | mm | in. | mm | in. | mm |

CASE DIMENSIONS

CASE TYPE	CASE DIMENSIONS					
	LENGTH		WIDTH		HEIGHT	
A0	0.41 in.	10.3 mm	0.5 in.	12.6 mm	0.91 in.	23.1 mm
A00	0.31 in.	7.9 mm	0.31 in.	7.9 mm	0.91 in.	23.1 mm
0.25 MSWS	0.5 in.	12.7 mm	0.37 in.	9.4 mm	0.5 in.	12.7 mm
0.5 MSWS	0.76 in.	19.3 mm	0.61 in.	15.5 mm	0.75 in.	19 mm

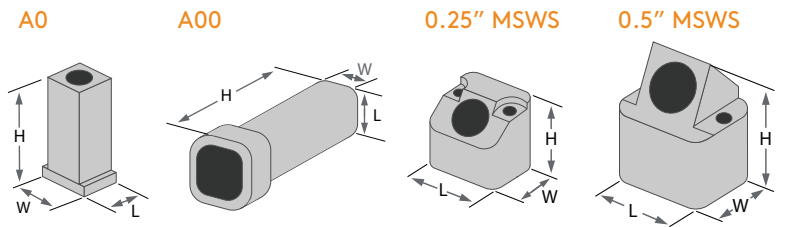

WEDGES

WEDGE TYPE	DESCRIPTION	PART NUMBER	DIMENSIONS					
			LENGTH	WIDTH	HEIGHT			
0.25" MSWS	Standard wedge for 0.25MSWS phased array probe - Designed for azimuthal scanning from 40 to 70 degree using SW - 55deg SW nominal angle	WS0.25MSWS-55S-FLAT	0.75 in.	19 mm	0.70 in.	17.8 mm	0.38 in.	9.7 mm
	Standard wedge for 0.25MSWS phased array probe - Designed for azimuthal scanning from 40 to 70 degree using LW - 55deg LW nominal angle	WS0.25MSWS-55L-FLAT	0.58 in.	14.7 mm	0.70 in.	17.8 mm	0.28 in.	7.1 mm
0.5" MSWS	Standard wedge for 0.5MSWS phased array probe - Designed for azimuthal scanning from 40 to 70 degree using SW - 55deg SW nominal angle	WS0.5MSWS-55S-FLAT	1.20 in.	30.5 mm	0.95 in.	24.1 mm	0.70 in.	17.8 mm
	Standard wedge for 0.5MSWS phased array probe - Designed for azimuthal scanning from 40 to 70 degree using LW - 55deg LW nominal angle	W0.5MSWS-55L-FLAT	0.81 in.	20.6 mm	0.95 in.	24.1 mm	0.35 in.	8.9 mm
A00	Standard wedge for A00 phased array probe - Designed for azimuthal scanning from 35 to 60 degree using SW - 45deg SW nominal angle	WSA00-45S-FLAT	0.83 in.	21.1 mm	0.55 in.	14 mm	0.47 in.	11.9 mm
	Standard wedge for A00 phased array probe - Designed for azimuthal scanning from 40 to 70 degree using SW - 60deg SW nominal angle	WSA00-60S-FLAT	0.83 in.	21.1 mm	0.55 in.	14 mm	0.51 in.	13 mm

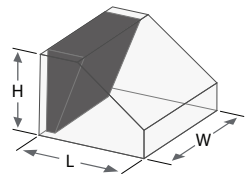

Contoured wedges available upon request

LOW-PROFILE

Low-profile arrays are designed to inspect small-diameter or thin-walled pipes for flaws and defects. A15 and A25 cases are also useful for applications with low clearance at the inspection area. Low-profile wedges optimize the arrays for small-diameter weld inspection. Custom low-profile arrays and wedges can be ordered upon request.



PHASED ARRAYS

CASE	PART NUMBER	FREQUENCY	ELEMENTS	APERTURE		PITCH		ELEVATION		CABLE LENGTH
A15	5CCEV35-16-A15-8X10-2.5-IPEX	5	16	0.31	8	0.020	0.50	0.38	10	2.5M (8.2 ft.)
	7.5CCEV35-16-A15-8X10-2.5-IPEX	7.5	16	0.31	8	0.020	0.50	0.38	10	2.5M (8.2 ft.)
	7.5CCEV35-32-A15-8X10-2.5-IPEX	7.5	32	0.31	8	0.010	0.25	0.38	10	2.5M (8.2 ft.)
	10CCEV35-16-A15-8X10-2.5-IPEX	10	16	0.31	8	0.020	0.50	0.38	10	2.5M (8.2 ft.)
	10CCEV35-32-A15-8X10-2.5-IPEX	10	32	0.31	8	0.010	0.25	0.38	10	2.5M (8.2 ft.)
A25	3.5DL16-A25-12X5-2.5-IPEX	3.5	16	0.47	12	0.030	0.75	0.20	5	2.5M (8.2 ft.)
	5DL16-A25-12X5-2.5-IPEX	5	16	0.47	12	0.030	0.75	0.20	5	2.5M (8.2 ft.)

Other cable lengths available upon request.

| in. | mm | in. | mm | in. | mm |

CASE DIMENSIONS

CASE TYPE	CASE DIMENSIONS					
	LENGTH		WIDTH		HEIGHT	
A15	1.03 in.	26.2 mm	0.86 in.	21.8 mm	0.39 in.	9.9 mm
A25	0.70 in.	17.8 mm	0.47 in.	11.9 mm	0.54 in.	13.7 mm

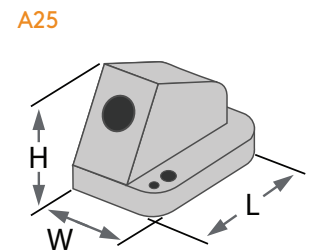
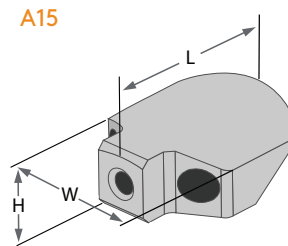

WEDGES

WEDGE TYPE	DESCRIPTION	PART NUMBER	DIMENSIONS		
			LENGTH	WIDTH	HEIGHT
A15	Standard wedge for A15 phased array probe - Designed for azimuthal scanning from 40 to 70 degree using SW - 60deg SW nominal angle - Irrigation, probe holder fixtures	WSA15-60S-FLAT-IH	0.72 in. 18.3 mm	0.86 in. 21.8 mm	0.44 in. 11.2 mm
A25	22-Deg Inc, 3.80-Deg Roof, Flat (Only works with Eddyfi A25 arrays)	WSA25-22I---	Contact for dimensions		
	Wedge assembly for TRL inspection using A25 probes - Irrigation channels and probe holder fixtures - 22.0° wedge angle / 12.0° roof angle - For NPS 0.5 (0.840") - Circumferential flaw detection	WSA25-TRL-AOD0.5-IH-22.0W-12.0R			
	Wedge assembly for TRL inspection using A25 probes - Irrigation channels and probe holder fixtures - 22.0° wedge angle / 11.0° roof angle - For NPS 0.75 (1.050") - Circumferential flaw detection	WSA25-TRL-AOD0.75-IH-22.0W-11.0R			
	Wedge assembly for TRL inspection using A25 probes - Irrigation channels and probe holder fixtures - 22.0° wedge angle / 10.0° roof angle - For NPS 1 (1.315") - Circumferential flaw detection	WSA25-TRL-AOD1.0-IH-22.0W-10.0R			
	Wedge assembly for TRL inspection using A25 probes - Irrigation channels and probe holder fixtures - 22.0° wedge angle / 8.5° roof angle - For NPS 1.25 (1.660") - Circumferential flaw detection	WSA25-TRL-AOD1.25-IH-22.0W-8.5R			
	Wedge assembly for TRL inspection using A25 probes - Irrigation channels and probe holder fixtures - 22.0° wedge angle / 8.0° roof angle - For NPS 1.5 (1.900") - Circumferential flaw detection	WSA25-TRL-AOD1.5-IH-22.0W-8.0R			
	Wedge assembly for TRL inspection using A25 probes - Irrigation channels and probe holder fixtures - 22.0° wedge angle / 7.5° roof angle - For NPS 2.0 (2.375") - Circumferential flaw detection	WSA25-TRL-AOD2.0-IH-22.0W-7.5R			
	Wedge assembly for TRL inspection using A25 probes - Irrigation channels and probe holder fixtures - 22.0° wedge angle / 6.5° roof angle - For NPS 2.5 (2.875") - Circumferential flaw detection	WSA25-TRL-AOD2.5-IH-22.0W-6.5R			
	Wedge assembly for TRL inspection using A25 probes - Irrigation channels and probe holder fixtures - 22.0° wedge angle / 6.0° roof angle - For NPS 3.0 (3.500") - Circumferential flaw detection	WSA25-TRL-AOD3.0-IH-22.0W-6.0R			
	Wedge assembly for TRL inspection using A25 probes - Irrigation channels and probe holder fixtures - 22.0° wedge angle / 5.5° roof angle - For NPS 3.5 (4.000") - Circumferential flaw detection	WSA25-TRL-AOD3.5-IH-22.0W-5.5R			
	Wedge assembly for TRL inspection using A25 probes - Irrigation channels and probe holder fixtures - 22.0° wedge angle / 5.5° roof angle - For NPS 4.0 (4.500") - Circumferential flaw detection	WSA25-TRL-AOD4.0-IH-22.0W-5.5R			
	Wedge assembly for TRL inspection using A25 probes - Irrigation channels and probe holder fixtures - 22.0° wedge angle / 3.8° roof angle - Flat	WSA25-TRL-FLAT-IH-22.0W-3.8R			
	Wedge kit for TRL inspection using A25 probes - Irrigation channels and probe holder fixtures - flat wedge plus 9 curved wedges NPS 0.5 (0.840") to NPS 4.0 (4.500") - Circumferential flaw detection	WSA25-TRL-KIT-IH			

A25 wedges typically vary based on the application. While we do have some wedges listed in this chart, we encourage a discussion on your application requirements. Contoured wedges available upon request.

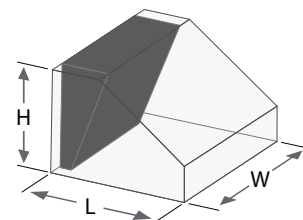

M15 - MATRIX ARRAY

Some mission-critical components of similar size and thickness as boiler tubes, but with more acoustically challenging metallurgy require more strict detection & sizing criteria. To overcome the challenge of the small diameter tube diverging the UT beam, Eddyfi's design team considered the use of a 2D matrix probe design for the M15 probe line. Having columns and rows of elements allows to electronically focus the beam in both axis, so we can compensate for the diverging effect of the inspection surface.

Low-profile casing and wedges, similar to the A15 series, allow deployment in low-radial clearance conditions and ensure mechanical compatibility with most low-profile boiler-tube type scanners.



ARRAYS

CASE	PART NUMBER	FREQUENCY	ELEMENTS	APERTURE		PITCH		CABLE LENGTH
M15	5M9x7-M15-9.9x7.7-2.5-IPEX	5	9x7	0.39x0.30	9.9x7.7	0.043x0.043	1.10x1.10	2.5M (8.2 ft.)
Other cable lengths available upon request				<i>in.</i>	<i>mm</i>	<i>in.</i>	<i>mm</i>	

CASE DIMENSIONS

CASE TYPE	CASE DIMENSIONS					
	LENGTH		WIDTH		HEIGHT	
M15	1.08 in.	27.4 mm	0.86 in.	21.8 mm	0.48 in.	12.2 mm

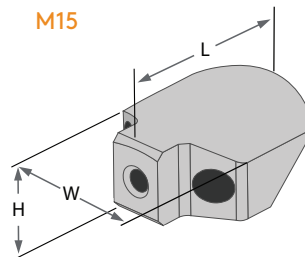

TOFD

Time-Of-Flight Diffraction (TOFD) is an inspection method used to determine the size of cracks in metallic welds. It requires highly-damped broadband transducers and wedges that generate refracted longitudinal waves (L-waves). Eddyfi Technologies TOFD transducers have state-of-the-art piezocomposite elements and quick swap, screw-in wedge attachment.



TOFD

PART NUMBER	FREQUENCY	ELEMENT DIAMETER	
TOFD2.25-6-ST1-MICRODOT	2.25	0.25	6
TOFD5-3-ST1-MICRODOT	5	0.125	3
TOFD5-6-ST1-MICRODOT	5	0.25	6
TOFD7.5-3-ST1-MICRODOT	7.5	0.125	3
TOFD7.5-6-ST1-MICRODOT	7.5	0.25	6
TOFD10-3-ST1-MICRODOT	10	0.125	3
TOFD10-6-ST1-MICRODOT	10	0.25	6
TOFD15-3-ST1-MICRODOT	15	0.125	3
TOFD15-6-ST1-MICRODOT	15	0.25	6

| in. | mm |

PART NUMBER	FREQUENCY	ELEMENT DIAMETER	
TOFD2.25-6-ST1-LEMO00	2.25	0.25	6
TOFD5-3-ST1-LEMO00	5	0.125	3
TOFD5-6-ST1-LEMO00	5	0.25	6
TOFD7.5-3-ST1-LEMO00	7.5	0.125	3
TOFD7.5-6-ST1-LEMO00	7.5	0.25	6
TOFD10-3-ST1-LEMO00	10	0.125	3
TOFD10-6-ST1-LEMO00	10	0.25	6
TOFD15-3-ST1-LEMO00	15	0.125	3
TOFD15-6-ST1-LEMO00	15	0.25	6

| in. | mm |

CASE DIMENSIONS

ELEMENT DIAMETER		A		B		C	
in.	mm						
0.125	3	0.37 in.	9.4 mm	0.72 in.	18.3 mm	0.41 in.	10.4 mm
0.25	6	0.37 in.	9.4 mm	0.72 in.	18.3 mm	0.41 in.	10.4 mm

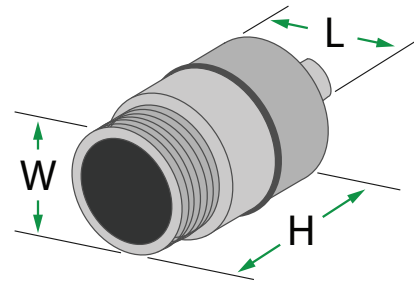

WEDGES

WEDGE TYPE	DESCRIPTION	PART NUMBER	DIMENSIONS					
			LENGTH		WIDTH		HEIGHT	
TOFD	TOFD wedge for ST1 type TOFD probe - 45-degree LW nominal angle in carbon steel - Irrigation channels and probe holder fixtures.	WEDGE-TOFD-45LW-ST1-IHC	0.83 in.	21.1 mm	1.25 in.	31.8 mm	0.50 in.	12.7 mm
	TOFD wedge for ST1 type TOFD probe - 60-degree LW nominal angle in carbon steel - Irrigation channels and probe holder fixtures.	WEDGE-TOFD-60LW-ST1-IHC	0.83 in.	21.1 mm	1.25 in.	31.8 mm	0.50 in.	12.7 mm
	TOFD wedge for ST1 type TOFD probe - 70-degree LW nominal angle in carbon steel - Irrigation channels and probe holder fixtures.	WEDGE-TOFD-70LW-ST1-IHC	0.83 in.	21.1 mm	1.25 in.	31.8 mm	0.50 in.	12.7 mm

Contoured wedges available upon request

CORROSION

Corrosion arrays are optimized to increase efficiency and probability of detection for corrosion and erosion scanning applications. Typical applications for these arrays include large plates, bars, and other parts with large surface areas. The larger scanning width decreases the inspection time dramatically compared to single-element inspections.



PHASED ARRAYS

CASE	PART NUMBER	FREQUENCY	ELEMENTS	APERTURE	PITCH	ELEVATION	CABLE LENGTH
CL	5DL32-CL-2x(48x5)-2.5-IPEX	5	32 Transmit 32 Receive	1.89 48	0.060 1.50	0.20 5	2.5M (8.2 ft.)
CS	5DL32-CS-2x(24x5)-2.5-IPEX	5	32 Transmit 32 Receive	0.94 24	0.030 0.75	0.20 5	2.5M (8.2 ft.)
CS	10DL64-CS-2x(22.4x5)-2.5-IPEX	10	64 Transmit 64 Receive	0.88 22.4	0.014 0.35	0.20 5	2.5M (8.2 ft.)
RD	7.5DL32-RD-2x(48x5)-2.5-IPEX	7.5	32 Transmit 32 Receive	1.89 48	0.060 1.50	0.20 5	2.5M (8.2 ft.)

Other cable lengths available upon request

in. | *mm* | *in.* | *mm* | *in.* | *mm* |

CASE DIMENSIONS

CASE TYPE	CASE DIMENSIONS					
	WIDTH		LENGTH		HEIGHT	
CL	0.95 in.	24.1 mm	2.58 in.	65.5 mm	1.0 in.	25.4 mm
CS	0.95 in.	24.1 mm	1.61 in.	40.9 mm	1.0 in.	25.4 mm
Removable	1.25 in.	31.8 mm	2.58 in.	65.5 mm	1.20 in.	30.5 mm

REMOVABLE

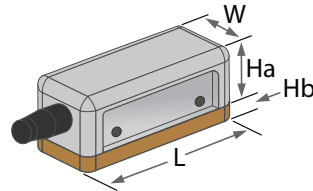

CL

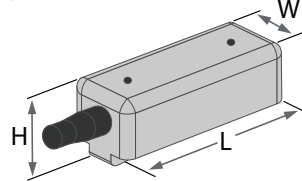

CS

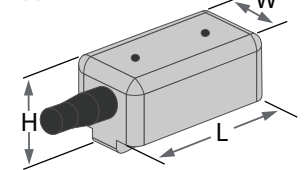

WEAR BARS

CASE TYPE	DESCRIPTION
CS	Ported Wear Plate, Flat, Porting
CL	Ported Wear Plate, Flat, Porting
Removable	Removable Sled, 3mm (0.12") gimbals holes

Contact us for scanner and wear bar compatibility information

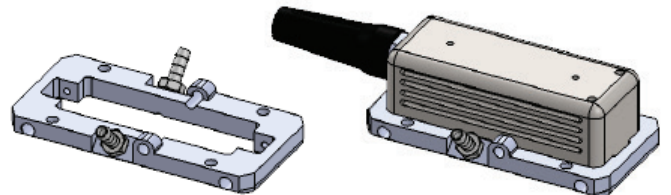

FLEXIBLE ARRAY

Flexible array probes are perfect for applications on curved metals and composites and can flex to fit a wide range of radii. Flexible arrays improve the inspection of complex geometry by reducing distortion and loss of sensitivity created by complex coupling requirements. Eddyfi Technologies' flexible arrays are designed to meet the needs of various complex inspections with increased flaw detection and quicker inspection time.

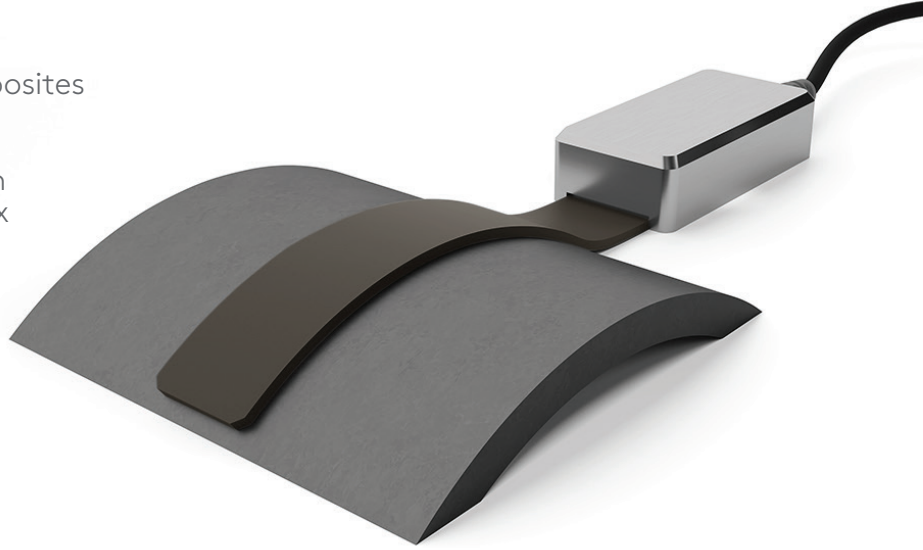

ARRAYS

PART NUMBER	FREQUENCY	ELEMENTS	APERTURE		PITCH		ELEVATION		CABLE LENGTH
5L64-FLEX-64X7-3-IPEX	5	64	2.52	64	0.04	1	0.28	7	3.0M (9.2 ft.)
7L64-FLEX-64X7-3-IPEX	7	64	2.52	64	0.04	1	0.28	7	3.0M (9.2 ft.)
Other cable lengths available upon request			<i>in.</i>	<i>mm</i>	<i>in.</i>	<i>mm</i>	<i>in.</i>	<i>mm</i>	



CASE DIMENSIONS

CASE DIMENSIONS							
La		H		W		Lb	
2.57 in.	65.3 mm	0.64 in.	16.3 mm	1.27 in.	32.3 mm	4.7 in.	119.4 mm

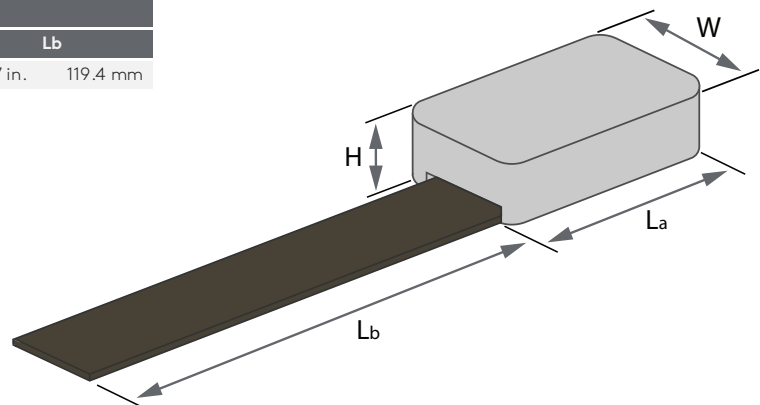

WHEELARRAY

The WheelArray™ is a unique tool and ultrasonic test tool used to increase inspection productivity of large surface areas associated with composite materials and metal plates. WheelArray is offered in five test frequencies, and the wheel can be replaced or swapped out by the end-user in the field.

Prior to the inspection, only a mist of water or other suitable couplant needs to be sprayed on the test area.

Custom WheelArrays can be requested including custom frequency, elements, pitch, cable length, and connector type.



COMPLETE WHEELARRAY KIT

PART NUMBER	FREQUENCY	ELEMENTS	APERTURE		PITCH		ELEVATION		SOUND PATH		BEAM WIDTH	
1L32-WHEELARRAY-51.2X12-5-IPEX-KIT	1	32	2.01 x 0.47	51.2 x 12	0.06	1.6	0.47	12	1.0	25.4	2.0	51.2
2.25L64-WHEELARRAY-51.2X6.4-IPEX-KIT	2.25	64	2.01 x 0.25	51.2 x 6.4	0.03	0.8	0.25	6.4	1.0	25.4	2.0	51.2
3.5L64-WHEELARRAY-51.2X6.4-IPEX-KIT	3.5	64	2.01 x 0.25	51.2 x 6.4	0.03	0.8	0.25	6.4	1.0	25.4	2.0	51.2
5L64-WHEELARRAY-51.2X6.4-IPEX-KIT	5	64	2.01 x 0.25	51.2 x 6.4	0.03	0.8	0.25	6.4	1.0	25.4	2.0	51.2
10L64-WHEELARRAY-51.2X6.4-IPEX-KIT	10	64	2.01 x 0.25	51.2 x 6.4	0.03	0.8	0.25	6.4	1.0	25.4	2.0	51.2

| in. | mm | in. | mm | in. | mm | in. | mm | in. | mm | in. | mm |

REPLACEMENT ARRAY & WHEEL

PART NUMBER	FREQUENCY	ELEMENTS	APERTURE		PITCH		ELEVATION		SOUND PATH		BEAM WIDTH	
1L32-WHEELARRAY-51.2X12-5-IPEX-SPARE	1	32	2.01 x 0.47	51.2 x 12	0.06	1.6	0.47	12	1.0	25.4	2.0	51.2
2.25L64-WHEELARRAY-51.2X6.4-IPEX-SPARE	2.25	64	2.01 x 0.25	51.2 x 6.4	0.03	0.8	0.25	6.4	1.0	25.4	2.0	51.2
3.5L64-WHEELARRAY-51.2X6.4-IPEX-SPARE	3.5	64	2.01 x 0.25	51.2 x 6.4	0.03	0.8	0.25	6.4	1.0	25.4	2.0	51.2
5L64-WHEELARRAY-51.2X6.4-IPEX-SPARE	5	64	2.01 x 0.25	51.2 x 6.4	0.03	0.8	0.25	6.4	1.0	25.4	2.0	51.2
10L64-WHEELARRAY-51.2X6.4-IPEX-SPARE	10	64	2.01 x 0.25	51.2 x 6.4	0.03	0.8	0.25	6.4	1.0	25.4	2.0	51.2

| in. | mm | in. | mm | in. | mm | in. | mm | in. | mm | in. | mm |

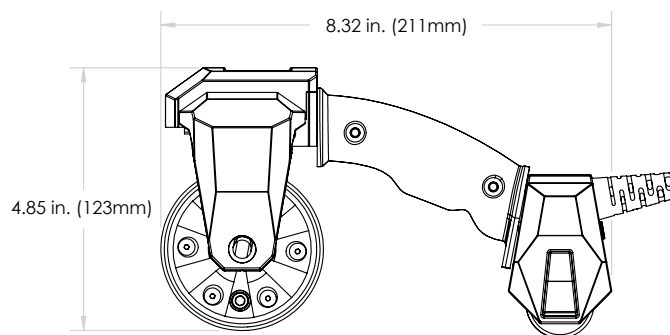
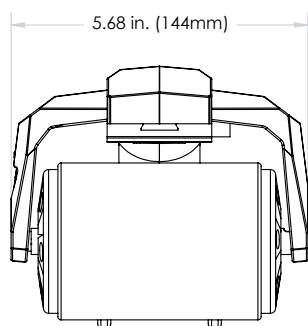

IMMERSION LINEAR

Much like conventional immersion transducers, immersion arrays are used in automatic and manual scanning systems using water or another liquid to couple to parts with complex geometries or large surface areas. Immersion inspection offers near-surface resolution superior to that of contact transducers. Immersion transducers are also effective for inspection of composite materials.



ARRAYS

CASE	PART NUMBER	FREQUENCY	ELEMENTS	APERTURE		PITCH		ELEVATION		CABLE LENGTH
I1	5L64-I1-38.4X10-2.5-IPEX	5	64	3.02	76.8	0.024	0.60	0.39	10	2.5M (8.2 ft.)
	10L64-I1-38.4X10-2.5-IPEX	10	64	1.51	38.4	0.024	0.60	0.39	10	2.5M (8.2 ft.)
I2	5L128-I2-76.8X10-2.5-IPEX	5	128	3.02	76.8	0.024	0.60	0.39	10	2.5M (8.2 ft.)
	10L128-I2-64X7-2.5-IPEX	10	128	2.52	64	0.020	0.50	0.28	7	2.5M (8.2 ft.)
I3	2.25L128-I3-96X12-5-IPEX	2.25	128	3.78	96	0.030	0.75	0.47	12	5M (16.4 ft.)
	5L128-I3-96X10-5-IPEX	5	128	3.78	96	0.024	0.60	0.38	10	5M (16.4 ft.)
I4	5L64-I4-64X7-3-IPEX	5	64	2.52	64	0.030	1.00	0.28	7	3M (9.8 ft.)
	7.5L64-I4-64x7-7.5-IPEX	7.5	64	2.52	64	0.030	1.00	0.28	7	7.5M (24.6 ft.)

Other cable lengths available upon request

| in. | mm | in. | mm | in. | mm |

CASE DIMENSIONS

CASE TYPE	CASE DIMENSIONS					
	LENGTH		WIDTH		HEIGHT	
I1	1.97 in.	50 mm	0.75 in.	19 mm	0.98 in.	24.9 mm
I2	3.27 in.	83.1 mm	0.83 in.	21.1 mm	1.38 in.	35.1 mm
I3	4.02 in.	102.1 mm	0.83 in.	21.1 mm	1.38 in.	35.1 mm
I4	3.08 in.	78.2 mm	0.97 in.	24.6 mm	1.00 in.	25.4 mm

I1

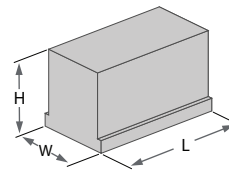

I2

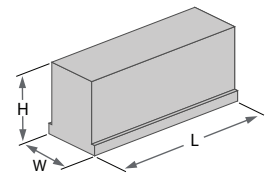

I3

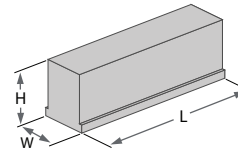

I4

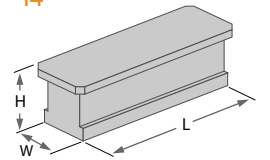

CONTACT MEMBRANE

Contact membrane arrays are linear arrays specially designed and optimized for the inspection of threaded bolts or applications with rough surfaces. The membrane allows for effective coupling on those rough surfaces and can be replaced to extend the life of the array. Contact membrane transducers have side-mounted cables but can be specially ordered with top-mounted cables.



PHASED ARRAYS

CASE	PART NUMBER	FREQUENCY	ELEMENTS	APERTURE		PITCH		ELEVATION		CABLE LENGTH
A24	4L16-A24-16X16-2.5-IPEX	4	16	0.63	16	0.040	1.00	0.63	16	2.5M (8.2 ft.)
B S	2L16-BS-24X24-2.5-IPEX	2	16	0.94	24	0.060	1.50	0.94	24	2.5M (8.2 ft.)
	4L16-BS-24X24-2.5-IPEX	4	16	0.94	24	0.060	1.50	0.94	24	2.5M (8.2 ft.)
MBS	2L16-MBS-10X10-2.5-IPEX	2	16	0.39	10	0.025	0.63	0.39	10	2.5M (8.2 ft.)
	4L16-MBS-10X10-2.5-IPEX	4	16	0.39	10	0.025	0.63	0.39	10	2.5M (8.2 ft.)

Other cable lengths available upon request

| in. | mm | in. | mm | in. | mm |

CASE DIMENSIONS

CASE TYPE	CASE DIMENSIONS			
	A		B	
A24	1.07 in.	27.2 mm	1.75 in.	44.5 mm
MBS	0.98 in.	24.9 mm	1.61 in.	40.1 mm
BS	1.77 in.	45 mm	2.41 in.	61.2 mm

A24

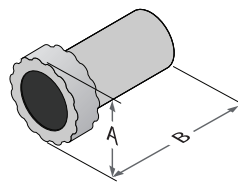

B S

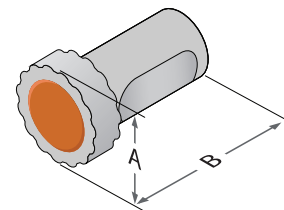

MBS

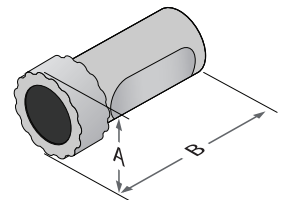

Illustration of the ceramic in a contact membrane linear array.

TFM ARRAY

Total Focusing Method (TFM) is an algorithm used to translate the inspection information gathered from Full Matrix Capture (FMC). This process allows for enhanced imaging by focusing at all points within the inspection area. The use of 64-element probes having a small pitch, hence high elementary divergence, yield better TFM performances.

AL-TFM ARRAYS

CASE	PART NUMBER	FREQUENCY	ELEMENTS	APERTURE	PITCH	ELEVATION	CABLE LENGTH
AL-TFM	5L64-AL-TFM-19.2X15-2.5-IPEX-DF50	5	64	0.75 19.2	0.012 0.30	0.59 15	2.5M (8.2 ft.)
	5L64-AL-TFM-19.2X15-2.5-IPEX-DF15	5	64	0.75 19.2	0.012 0.30	0.59 15	2.5M (8.2 ft.)
	10L64-AL-TFM-19.2X15-2.5-IPEX-DF50	10	64	0.75 19.2	0.012 0.30	0.59 15	2.5M (8.2 ft.)

Custom cable lengths available upon request

| in. | mm | in. | mm | in. | mm |

DLA-TFM ARRAYS

CASE	PART NUMBER	FREQUENCY	ELEMENTS	APERTURE	PITCH	ELEVATION	CABLE LENGTH
DLA-TFM	10DL2x64-DLA-TFM-2x(24X5)-2.5-IPEX	10	2x64	0.08x0.94 2x24	0.015 0.375	0.20 5	2.5M (8.2 ft.)

Other cable lengths available upon request

| in. | mm | in. | mm | in. | mm |

CASE DIMENSIONS

CASE TYPE	CASE DIMENSIONS					
	LENGTH		WIDTH		HEIGHT	
AL	1.30 in.	33 mm	0.95 in.	41.1 mm	0.98 in.	24.9 mm
CS	0.95 in.	24.1 mm	1.61 in.	40.9 mm	1.0 in.	25.4 mm

AL-TFM

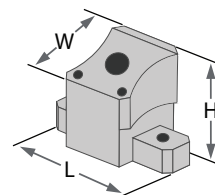

DLA-TFM

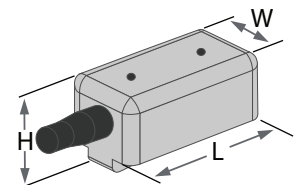

MATRIX ARRAYS

Matrix array transducers enable enhanced phased array inspections and full matrix capture that provides better probability of detection, improved flaw sizing & characterization, enhanced imaging, and faster inspection scans. Whether it's a simple 4 x 8 element array for weld inspection or as complicated as a 2048-element array, Eddyfi Technologies can prove a design in 3D computer simulation and easily change key variables such as frequency and pitch before the final design and fabrication process begins.

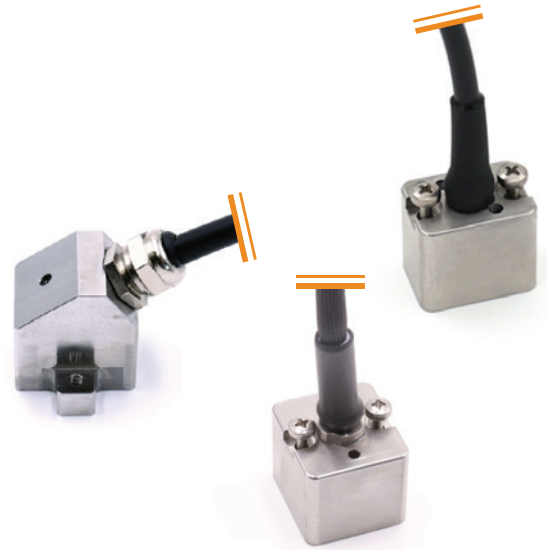

ARRAYS

CASE	PART NUMBER	FREQUENCY	ELEMENTS	APERTURE		PITCH		CABLE LENGTH
AM	5M9x7-AM-9.9x7.7-2.5-IPEX	5	9x7	0.39x0.30	9.9x7.7	0.043x0.043	1.10x1.10	2.5M (8.2 ft.)
AL	2.25M9x7-AL-15.8x12-2.5-IPEX	2.25	9x7	0.62x0.47	15.8x12	0.069x0.067	1.76x1.71	2.5M (8.2 ft.)
A17	2.25M7x4-A17-18.9x12-2.5-IPEX	2.25	7x4	0.74x0.47	18.9x12	0.106x0.118	2.70x3.00	2.5M (8.2 ft.)
MED	2.25M10x3-MED-20x12-2.5-IPEX	2.25	10x3	0.79x0.47	20x12	0.079x0.157	2.00x4.00	2.5M (8.2 ft.)
MED	1.5M8x4-MED-20x12-2.5-IPEX	1.5	8x4	0.79x0.47	20x12	0.099x0.118	2.50x3.00	2.5M (8.2 ft.)
MED	3.5M16x2-MED-20x12-2.5-IPEX	3.5	16x2	0.79x0.47	20x12	0.049x0.235	1.25x6.00	2.5M (8.2 ft.)
A11	5M16x4-A11-22.4x8-2.5-IPEX	5	16x4	0.88x0.31	22.4x8	0.055x0.078	1.40x2.00	2.5M (8.2 ft.)
A10	10M16x4-A10-22.4x8-2.5-IPEX	10	16x4	0.88x0.31	22.4x8	0.055x0.078	1.40x2.00	2.5M (8.2 ft.)
A11	7.5M16x4-A11-22.4x8-2.5-IPEX	7.5	16x4	0.88x0.31	22.4x8	0.055x0.078	1.40x2.00	2.5M (8.2 ft.)

Other cable lengths available upon request

| in. | mm | in. | mm |

CASE DIMENSIONS

CASE TYPE	CASE DIMENSIONS					
	LENGTH		WIDTH		HEIGHT	
AM	1.18 in.	30 mm	0.63 in.	16 mm	0.98 in.	24.9 mm
AL	1.30 in.	33 mm	0.95 in.	41.1 mm	0.98 in.	24.9 mm
A17	1.34 in.	34 mm	0.63 in.	16 mm	0.98 in.	24.9 mm
MED	1.18 in.	30 mm	0.63 in.	16 mm	0.79 in.	20 mm
A10	0.91 in.	23.1 mm	0.63 in.	16 mm	0.79 in.	20 mm
A11	0.98 in.	24.9 mm	0.91 in.	23.1 mm	0.79 in.	20 mm

AM

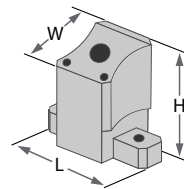

AL

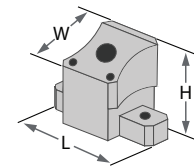

A10

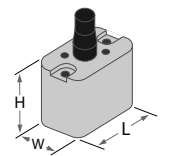

A11

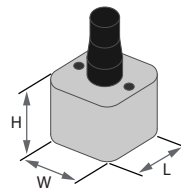

A17

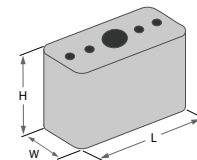

MED

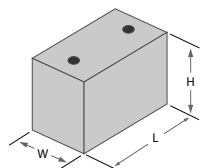

Matrix array wedges usually have special requirements. Please contact us for your application requirements.

DUAL MATRIX ARRAYS

The use of transmit-receive configurations yields better sensitivity and Signal-to-Noise Ratio (SNR). Compression waves are less affected by propagation through anisotropic materials than Shear waves. With its 2D dual matrix array probe family, Eddyfi Technologies offers a comprehensive solution for the inspection of coarse-grained, austenitic materials, corrosion-resistant alloys, and dissimilar metal welds, offering a superior SNR ratio. The beam skewing capability of 2D matrix array probes improves the detection capability of misoriented flaws.



ARRAYS

CASE	PART NUMBER	FREQUENCY	ELEMENTS	APERTURE		PITCH		CABLE LENGTH
A27	4DM2x32(16x2)-A27-16X6-2.5-IPEX	4	2x32(16x2)	0.63x0.24	16x6	0.039x0.120	1.00x3.00	2.5M (8.2 ft.)
A27	7.5DM2x32(16x2)-A27-16X6-2.5-IPEX	7.5	2x32(16x2)	0.63x0.24	16x6	0.039x0.120	1.00x3.00	2.5M (8.2 ft.)
MED	2.25DM2x30(10x3)-MED-20x12-2.5-IPEX	2.25	2x30(10x3)	0.79x0.47	20x12	0.039x0.120	1.00x3.00	2.5M (8.2 ft.)
LARGE	1.5DM2x32(8x4)-LARGE-28x16-2.5-IPEX	1.5	2x32(8x4)	1.10x0.63	28x16	0.138x0.158	3.50x4.00	2.5M (8.2 ft.)
MED	3.5DM2x32(16x2)-MED-20x12-2.5-IPEX	3.5	2x32(16x2)	0.79x0.47	20x12	0.049x0.235	1.25x6.00	2.5M (8.2 ft.)
MED	1.5DM2x32(8x4)-MED-20x12-2.5-IPEX	1.5	2x32(8x4)	0.79x0.47	20x12	0.099x0.118	2.50x3.00	2.5M (8.2 ft.)
MED	2.25DM2x32(8x4)-MED-20x12-2.5-IPEX	2.25	2x32(8x4)	0.79x0.47	20x12	0.099x0.118	2.50x3.00	2.5M (8.2 ft.)
A17	1.5DM2x28(7x4)-A17-18.9x12-2.5-IPEX	1.5	2x28(7x4)	0.74x0.47	18.9x12	0.106x0.118	2.70x3.00	2.5M (8.2 ft.)
A17	2.25DM2x28(7x4)-A17-18.9x12-2.5-IPEX	2.25	2x28(7x4)	0.74x0.47	18.9x12	0.106x0.118	2.70x3.00	2.5M (8.2 ft.)
A17	4DM2x28(7x4)-A17-18.9x12-2.5-IPEX	4	2x28(7x4)	0.74x0.47	18.9x12	0.106x0.118	2.70x3.00	2.5M (8.2 ft.)

Other cable lengths available upon request

in. | mm | in. | mm |

CASE DIMENSIONS

CASE TYPE	CASE DIMENSIONS					
	LENGTH		WIDTH		HEIGHT	
A27	1.12 in.	28.4 mm	0.39 in.	9.9 mm	0.79 in.	20 mm
MED	1.18 in.	30 mm	0.63 in.	16 mm	0.79 in.	20 mm
LARGE	1.53 in.	39 mm	0.79 in.	20 mm	0.98 in.	25 mm
A17	1.34 in.	34 mm	0.63 in.	16 mm	0.98 in.	25 mm

A27

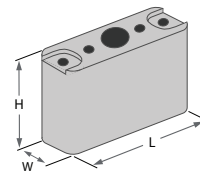

A17

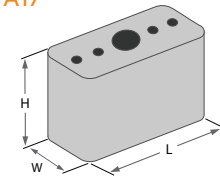

MED

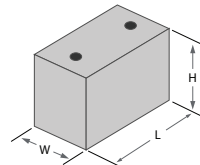

LARGE

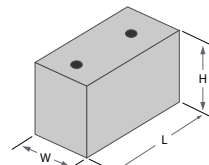

Matrix array wedges usually have special requirements. Please contact us for your application requirements.

HIGH-TEMP LINEAR

High-Temperature Linear Arrays are versatile arrays that optimize a wide range of high-temp applications including weld inspection, tube and pipe inspection, rails, pressure vessels, and many more. These arrays come standard with 2.5-meter (8.2 ft.) cables with IPEX connectors. Wedges for these arrays are available in two options: Mid Temp [100°C to 150°C (212°F to 302°F)] and High Temp [150°C to 200°C (302°F to 392°F)]. Each wedge type is also available in 30-70° and 0° refracted angle models.

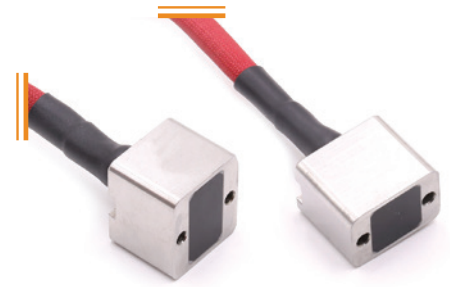

HIGH-TEMP ARRAYS

CASE	PART NUMBER	FREQUENCY	ELEMENTS	APERTURE		PITCH		ELEVATION		CABLE LENGTH
A10	5L16-A10-9.6X10-2.5-IPEX-HT	5	16	0.38x0.39	9.6x10	0.024	0.60	0.39	10	2.5M (8.2 ft.)
A11	5L32-A11-19.2X10-2.5-IPEX-HT	5	32	0.75x0.39	19.2x10	0.024	0.60	0.39	10	2.5M (8.2 ft.)
A12	5L64-A12-38.4x10-2.5-IPEX-HT	5	64	1.51x0.39	38.4x10	0.024	0.60	0.39	10	2.5M (8.2 ft.)

Other cable lengths available upon request

CASE DIMENSIONS

CASE TYPE	CASE DIMENSIONS					
	LENGTH		WIDTH		HEIGHT	
A10	0.91 in.	23.1 mm	0.63 in.	16 mm	0.79 in.	20.1 mm
A11	0.98 in.	24.9 mm	0.91 in.	23.1 mm	0.79 in.	20.1 mm
A12	1.77 in.	45 mm	0.91 in.	23.1 mm	0.79 in.	20.1 mm

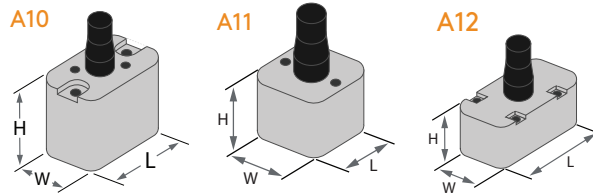

WEDGES

WEDGE TYPE	DESCRIPTION	PART NUMBER	LENGTH	WIDTH	HEIGHT
A10	High-temperature resistant wedge for A10 phased array probe - (100°-150°C) - Designed for linear scanning at 0 degree using LW - 0deg LW nominal angle - 20mm delay - Irrigation, probe holder fixtures & carbides	WSA10-0L-FLAT-IHC-20mm-MT	0.98 in. 24.9 mm	1.58 in. 40.1 mm	0.79 in. 20.1 mm
	High-temperature resistant wedge for A10 phased array probe - (100°-150°C) - Designed for azimuthal scanning from 40 to 70 degree using SW - 55deg SW nominal angle - Irrigation, probe holder fixtures & carbides	WSA10-55S-FLAT-IHC-MT	0.91 in. 23.1 mm	1.30 in. 33 mm	0.56 in. 14.2 mm
	High-temperature resistant wedge for A10 phased array probe - (150°-200°C) - Designed for linear scanning at 0 degree using LW - 0deg LW nominal angle - 20mm delay - Irrigation, probe holder fixtures & carbides	WSA10-0L-FLAT-IHC-20mm-HT	0.98 in. 24.9 mm	1.58 in. 40.1 mm	0.79 in. 20.1 mm
	High-temperature resistant wedge for A10 phased array probe - (150°-200°C) - Designed for azimuthal scanning from 40 to 70 degree using SW - 55deg SW nominal angle - Irrigation, probe holder fixtures & carbides	WSA10-55S-FLAT-IHC-HT	1.40 in. 35.6 mm	1.58 in. 40.1 mm	0.70 in. 17.8 mm
A11	High-temperature resistant wedge for A11 phased array probe - (100°-150°C) - Designed for linear scanning at 0 degree using LW - 0deg LW nominal angle - 20mm delay - Irrigation, probe holder fixtures & carbides	WSA11-0L-FLAT-IHC-20mm-MT	1.38 in. 35.1 mm	1.58 in. 40.1 mm	0.79 in. 20.1 mm
	High-temperature resistant wedge for A11 phased array probe - (100°-150°C) - Designed for azimuthal scanning from 40 to 70 degree using SW - 55deg SW nominal angle - Irrigation, probe holder fixtures & carbides	WSA11-55S-FLAT-IHC-MT	1.63 in. 41.4 mm	1.30 in. 33 mm	1.13 in. 28.7 mm
	High-temperature resistant wedge for A11 phased array probe - (150°-200°C) - Designed for linear scanning at 0 degree using LW - 0deg LW nominal angle - 20mm delay - Irrigation, probe holder fixtures & carbides	WSA11-0L-FLAT-IHC-20mm-HT	1.38 in. 35.1 mm	1.58 in. 40.1 mm	0.79 in. 20.1 mm
	High-temperature resistant wedge for A11 phased array probe - (150°-200°C) - Designed for azimuthal scanning from 40 to 70 degree using SW - 55deg SW nominal angle - Irrigation, probe holder fixtures & carbides	WSA11-55S-FLAT-IHC-HT	2.25 in. 57.2 mm	1.30 in. 33 mm	1.05 in. 26.7 mm
A12	High-temperature resistant wedge for A12 phased array probe - (100°C-150°C) - Designed for azimuthal scanning from 40 to 70 degree using SW - 55deg SW nominal angle - Irrigation, probe holder fixtures & carbides	WSA12-55S-FLAT-IHC-MT			

Contact for Dimensions

Contoured wedges available upon request

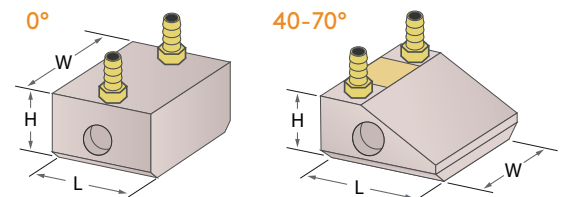

HIGH-TEMP DUAL LINEAR

The High-Temp Dual-Linear Corrosion Array is optimized for corrosion and erosion inspection at elevated temperatures. The transducer and its replaceable delay line are designed to withstand temperatures up to 200°C (395°F). This dual array features 32 transmit and 32 receive elements to provide larger beam coverage than conventional dual-element transducers. The transmit and receive element sets have an included angle to provide a pseudo-focusing effect in the inspected material. See page 14 for more ambient temperature dual-linear corrosion array options.

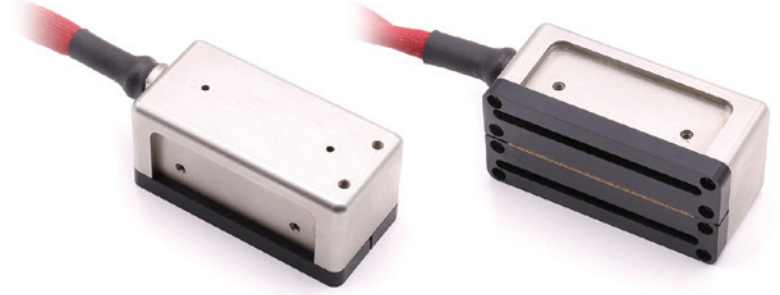

HIGH-TEMP ARRAYS

CASE	PART NUMBER	FREQUENCY	ELEMENTS	APERTURE		PITCH		ELEVATION		CABLE LENGTH
CL	5DL2x32-CL-2x(48X5)-5-IPEX-RD-HT	5	32 Transmit 32 Receive	1.89x0.20	48x5	0.060	1.50	0.20	5	5M (16.4 ft.)

Other cable lengths available upon request

| in. | mm | in. | mm | in. | mm |

DIMENSIONS

CASE TYPE	CASE DIMENSIONS							
	LENGTH		WIDTH		HEIGHT A		HEIGHT B	
CL	2.58 in.	65.5 mm	1.25 in.	31.8 mm	0.98 in.	24.9 mm	0.22 in.	5.6 mm
CL w/ Sled	2.58 in.	65.5 mm	1.25 in.	31.8 mm	0.98 in.	24.9 mm	0.23 in.	5.8 mm

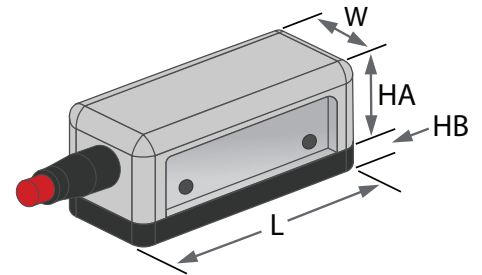

ACCESSORIES

WEDGE TYPE	PART NUMBER	DESCRIPTION
CL	WCL-RD-HT	High-temperature resistant replaceable delay line for CL dual linear probe
	WCL-SLED-HT	High-temperature resistant sled for CL dual linear probe

CONNECTORS, SPLITTERS, & ADAPTERS

PAUT CONNECTORS

- IPEX
- ZPAC
- Hypertronics
- Mentor
- Phasor
- Others available upon request



(L to R) Hypertronics, ZPAC, IPEX

CABLE CONNECTORS

MICRODOT — 

BNC — 

LEMO-00 — 

LEMO 1 — 

MCX* — 

RIGHT-ANGLE MCX* — 

*MCX connectors are snap-in and can swivel, preventing the risk of back threading.

PAUT SPLITTERS & ADAPTERS

Eddyfi Technologies can make splitters and extension cables with any phased array connector types and lengths that you need. To order a splitter or extension cable, contact us and provide us with the information based on the prompt below.

The connector type for end A (Array Side): _____

The connector type for end B (Instrument Side): _____

The cable length needed is: _____

SPLITTER

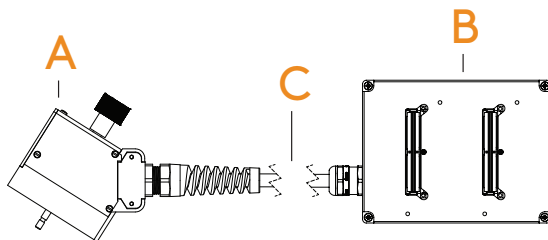

ADAPTER

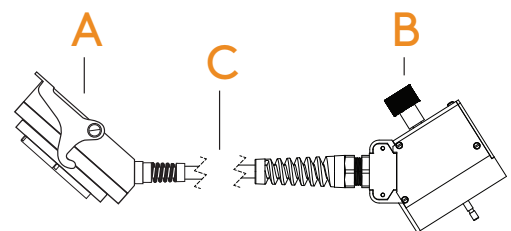

See page 46 for conventional accessories.

CONVENTIONAL TRANSDUCERS

CONVENTIONAL PART NUMBERS

CONVENTIONAL ACRONYM GUIDELINES

DFR-2.25-0.25-HR-MD-XX



FREQUENCY

In MHz

ELEMENT SIZE

In Inches

SERIES

HR - High Resolution
GP - General Purpose
C - Composite/Piezo-Composite

CONNECTOR TYPE

MD - Microdot
BNC
LEMO00 - Lemo-00
LEMO1 - Lemo 1
MCX
RAMCX - Right-Angle MCX

OTHER SPECS

If necessary, may include:
Spherical or Cylindrical Focus,
Customization
etc...

CONVENTIONAL WEDGE ACRONYM GUIDELINES

CW-SWS-45-0.5-XX

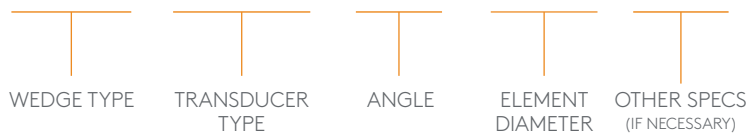

WEDGE TYPE

CW - Conventional

TRANSDUCER TYPE

QS
MSWS
AWS
SWS

ANGLE

In degrees

ELEMENT DIAMETER

In inches

OTHER SPECS

?????

CONTACT CR

The larger element sizes of **Model CR** provide greater scan widths and penetration for applications such as plate, billet, bars, thick-section parts, pipe, and tanks. They have side-mounted BNC connectors and removable comfort grip to reduce operator fatigue.

Model F are small diameter transducers with side-mounted Microdot connectors. All Model F transducers feature an ergonomic design for improved operator control and comfort.

GP series* offer the best combination of sensitivity and resolution. HR series* are highly damped for applications where high resolution is required. C series* have piezocomposite elements and offer superior penetration in highly-attenuative materials.



CR

FREQUENCY	ELEMENT DIAMETER		PART NUMBER	CABLE
1	0.5	12.7	C-CR-1.0-.50-GP-RABNC	BNC - BNC 6-ft (1.83 m)
	0.75	19	C-CR-1.0-.75-GP-RABNC	
	1	25.4	C-CR-1.0-1.0-GP-RABNC	
2.25	0.5	12.7	C-CR-3.5-.50-GP-RABNC	
	0.75	19	C-CR-3.5-.75-GP-RABNC	
	1	25.4	C-CR-3.5-1.0-GP-RABNC	
3.5	0.5	12.7	C-CR-3.5-.50-GP-RABNC	
	0.75	19	C-CR-3.5-.75-GP-RABNC	
	1	25.4	C-CR-3.5-1.0-GP-RABNC	
5	0.5	12.7	C-CR-5.0-.50-GP-RABNC	
	0.75	19	C-CR-5.0-.75-GP-RABNC	
	1	25.4	C-CR-5.0-1.0-GP-RABNC	
10	0.5	12.7	C-CR-10.0-.50-GP-RABNC	
	in.	mm		

DIMENSIONS

ELEMENT DIAMETER		A		B		
0.50	12.7	1.5	38.1	1.3	33	
0.75	19	1.75	44.5	1.3	33	
1	25.4	2	50.8	1.4	35.6	
	in.	mm	in.	mm	in.	mm

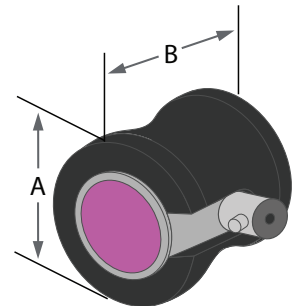

F FINGERTIP

FREQUENCY	ELEMENT DIAMETER		Part Number		
			GP	HR	C
1	0.5	12.7			C-F-1.0-0.5-C-RAMD
	0.25	6.4	C-F-2.25-.25-GP-RAMD		C-F-2.25-.25-C-RAMD
2.25	0.375	9.5	C-F-2.25-.375-GP-RAMD		C-F-2.25-.375-C-RAMD
	0.5	12.7	C-F-2.25-.50-GP-RAMD		C-F-2.25-.50-C-RAMD
	0.25	6.4	C-F-3.5-.25-GP-RAMD		C-F-3.5-.25-C-RAMD
3.5	0.375	9.5	C-F-3.5-.375-GP-RAMD		C-F-3.5-.375-C-RAMD
	0.5	12.7	C-F-3.5-.50-GP-RAMD		C-F-3.5-.50-C-RAMD
	0.25	6.4	C-F-5.0-.25-GP-RAMD	C-F-5.0-.25-HR-RAMD	C-F-5.0-.25-C-RAMD
5	0.375	9.5	C-F-5.0-.375-GP-RAMD	C-F-5.0-.375-HR-RAMD	C-F-5.0-.375-C-RAMD
	0.5	12.7	C-F-5.0-.50-GP-RAMD	C-F-5.0-.50-HR-RAMD	C-F-5.0-.50-C-RAMD
	0.25	6.4	C-F-10.0-.25-GP-RAMD	C-F-10-.25-HR-RAMD	
10	0.375	9.5	C-F-10-.375-GP-RAMD		
	in.	mm			

DIMENSIONS

ELEMENT DIAMETER		A		B		
0.25	6.4	0.58	14.7	0.66	16.8	
0.375	9.5	0.71	18	0.66	16.8	
0.50	12.7	0.83	21.1	0.66	16.8	
	in.	mm	in.	mm	in.	mm

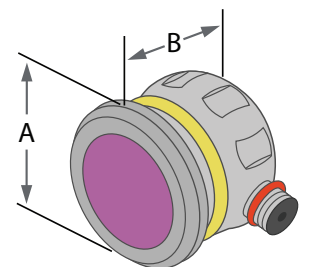

* See appendix for technical details (page 47)

DFR - DELAY-LINE

Model DFR are small-diameter delay-line transducers with side-mounted Microdot connectors. Removable delay line and highly damped piezoceramic elements enable measurement of very thin parts or detection of small near-surface flaws. Delay lines can be contoured for improved coupling to I.D. or O.D. curved parts. Custom sizes and shapes also available upon request.

HR series* are highly damped for applications where high resolution is required.



DFR

FREQUENCY	ELEMENT DIAMETER		PART NUMBER
			HR
2.25	0.25	6.4	DFR-2.25-0.25-HR-MD
	0.5	12.7	DFR-2.25-0.5-HR-MD
3.5	0.25	6.4	DFR-3.5-0.25-HR-MD
	0.5	12.7	DFR-3.5-0.5-HR-MD
5	0.25	6.4	DFR-5-0.25-HR-MD
	0.5	12.7	DFR-5-0.5-HR-MD
10	0.25	6.4	DFR-10-0.25-HR-MD
	0.5	12.7	DFR-10-0.5-HR-MD
15	0.25	6.4	DFR-15-0.25-HR-MD



FREQUENCY	ELEMENT DIAMETER		PART NUMBER
			HR
Nominal 20MHz	0.125	3.2	DFR-20-0.125-HR-MD

DIMENSIONS

ELEMENT DIAMETER		A		B				C	
				10mm DELAY		12.7mm DELAY			
0.125	3.2	0.5	12.7	0.83	21.1	0.95	24.1	0.3	7.6
0.25	6.4	0.5	12.7	0.83	21.1	0.95	24.1	0.3	7.6
0.5	12.7	0.88	22.4	1.03	26.2	1.15	29.2	0.6	15.2
<i>in.</i>	<i>mm</i>	<i>in.</i>	<i>mm</i>	<i>in.</i>	<i>mm</i>	<i>in.</i>	<i>mm</i>	<i>in.</i>	<i>mm</i>
MINI-DFR									
0.125	3.2	0.41	10.4	0.77	19.6	0.19	4.8		
<i>in.</i>	<i>mm</i>	<i>in.</i>	<i>mm</i>	<i>in.</i>	<i>mm</i>	<i>in.</i>	<i>mm</i>		

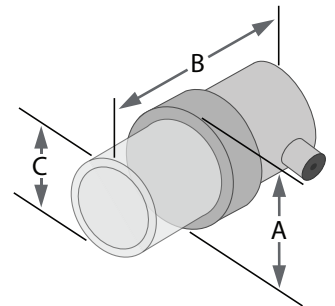

* See appendix for technical details (page 47)

PENCIL PROBE - DELAY-LINE

Pencil probes are designed for applications requiring a very small contact face, such as curved turbine blades or thickness measurement from the inside of a pit. They can be used with most flaw detectors and precision thickness gauges. Interchangeable delay lines are tapered to tip diameters of 0.065 inch (1.7mm) and 0.090 inch (2.3mm). Replaceable delay lines are available in packs of 10. The straight model features a removable handle, which also allows it to be used as a fingertip probe. All models have Microdot connectors.



PENCIL PROBES

FREQUENCY	PART NUMBER					
	STRAIGHT MD	STRAIGHT MCX	45deg MD	45deg MCX	90deg MD	90deg MCX
7.5	PEN-7.5-ST-MD	PEN-7.5-ST-MCX			PEN-7.5-90-MD	PEN-7.5-90-MCX
10	PEN-10-ST-MD		PEN-10-45-MD		PEN-10-90-MD	
15	PEN-15-ST-MD	PEN-15-ST-MCX	PEN-15-45-MD	PEN-15-45-MCX	PEN-15-90-MD	PEN-15-90-MCX

ACCESSORIES

DELAY 10-PK .065" (1.7mm) TIP	DELAY 10-PK .090" (2.3mm) TIP	Extension Handle
Delay-PEN-.065-10	Delay-PEN-.090-10	PEN-Extension Handle

DIMENSIONS

A		B		C			
1	25.4	0.6	15.2	0.42	10.7		
D		E		F		G	
0.4	10.2	0.09	2.3	4	101.6	0.42	10.7
in.	mm	in.	mm	in.	mm	in.	mm

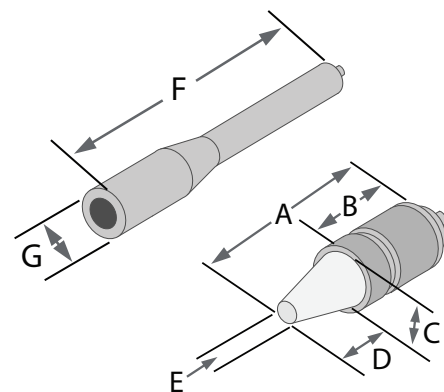

QS - ANGLE BEAM

Model QS features Quick Swap screw-in wedge attachment. They are available with top-mounted Microdot (MD) or new MCX low-profile swivel connectors. Piezocomposite (C series*) offer superior penetration and signal-to-noise ratio in highly-attenuative and coarse-grain materials.



QS

FREQUENCY	ELEMENT DIAMETER		PART NUMBER
			C*
1	0.375	9.5	QS-1-0.375-C-MCX
			QS-1-0.375-C-MD
	0.5	12.7	QS-1-0.5-C-MCX
			QS-1-0.5-C-MD
1.5	0.25	6.4	QS-1.5-0.25-C-MCX
			QS-1.5-0.25-C-MD
	0.375	9.5	QS-1.5-0.375-C-MCX
			QS-1.5-0.375-C-MD
0.5	12.7	QS-1.5-0.5-C-MCX	
		QS-1.5-0.5-C-MD	
2.25	0.25	6.4	QS-2.25-0.25-C-MCX
			QS-2.25-0.25-C-MD
	0.375	9.5	QS-2.25-0.375-C-MCX
			QS-2.25-0.375-C-MD
0.5	12.7	QS-2.25-0.5-C-MCX	
		QS-2.25-0.5-C-MD	
3.5	0.25	6.4	QS-3.5-0.25-C-MCX
			QS-3.5-0.25-C-MD
	0.375	9.5	QS-3.5-0.375-C-MCX
			QS-3.5-0.375-C-MD
0.5	12.7	QS-3.5-0.5-C-MCX	
		QS-3.5-0.5-C-MD	
5	0.25	6.4	QS-5-0.25-C-MCX
			QS-5-0.25-C-MD
	0.375	9.5	QS-5-0.375-C-MCX
			QS-5-0.375-C-MD
0.5	12.7	QS-5-0.5-C-MCX	
		QS-5-0.5-C-MD	
7.5	0.25	6.4	QS-7.5-0.25-C-MCX
			QS-7.5-0.25-C-MD
	0.375	9.5	QS-7.5-0.375-C-MCX
			QS-7.5-0.375-C-MD
0.5	12.7	QS-7.5-0.5-C-MCX	
		QS-7.5-0.5-C-MD	
10	0.25	6.4	QS-10-0.25-C-MCX
			QS-10-0.25-C-MD
	0.375	9.5	QS-10-0.375-C-MCX
			QS-10-0.375-C-MD
0.5	12.7	QS-10-0.5-C-MCX	
		QS-10-0.5-C-MD	
	<i>in.</i>	<i>mm</i>	

DIMENSIONS

ELEMENT DIAMETER		A	B		C	
0.25	6.4	3/8 - 32 UNEF	0.58	14.7	0.43	10.9
0.375	9.5	1/2 - 28 UNEF	0.58	14.7	0.54	13.7
0.5	12.7	5/8 - 24 UNEF	0.65	16.5	0.69	17.5
<i>in.</i>	<i>mm</i>		<i>in.</i>	<i>mm</i>	<i>in.</i>	<i>mm</i>

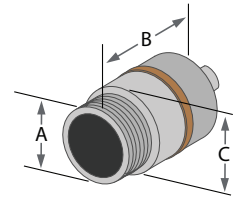

ACCESSORIES

ELEMENT DIAMETER		STANDARD WEDGES			
		ANGLE	CARBON STEEL	STAINLESS STEEL	ALUMINUM
0.25	6.4	30°	CW-QS-30-0.25-CS		
		45°	CW-QS-45-0.25-CS	CW-QS-45-0.25-SS	CW-QS-45-0.25-AL
		60°	CW-QS-60-0.25-CS	CW-QS-60-0.25-SS	CW-QS-60-0.25-AL
		70°	CW-QS-70-0.25-CS	CW-QS-70-0.25-SS	CW-QS-70-0.25-AL
0.375	9.5	30°	CW-QS-30-0.375-CS		
		45°	CW-QS-45-0.375-CS	CW-QS-45-0.375-SS	CW-QS-45-0.375-AL
		60°	CW-QS-60-0.375-CS	CW-QS-60-0.375-SS	
		70°	CW-QS-70-0.375-CS	CW-QS-70-0.375-SS	
0.5	12.7	30°	CW-QS-30-0.5-CS		
		45°	CW-QS-45-0.5-CS	CW-QS-45-0.5-SS	CW-QS-45-0.5-AL
		60°	CW-QS-60-0.5-CS	CW-QS-60-0.5-SS	CW-QS-60-0.5-AL
		70°	CW-QS-70-0.5-CS	CW-QS-70-0.5-SS	CW-QS-70-0.5-AL

ELEMENT DIAMETER		SHORT INDEX WEDGES			
		ANGLE	CARBON STEEL	STAINLESS STEEL	ALUMINUM
0.25	6.4	45°	CW-QS-45-0.25-CS-SI	CW-QS-45-0.25-SS-SI	CW-QS-45-0.25-AL-SI
		60°	CW-QS-60-0.25-CS-SI	CW-QS-60-0.25-SS-SI	CW-QS-60-0.25-AL-SI
		70°	CW-QS-70-0.25-CS-SI	CW-QS-70-0.25-SS-SI	CW-QS-70-0.25-AL-SI
0.375	9.5	30°			CW-QS-30-0.375-AL-SI
		45°	CW-QS-45-0.375-CS-SI	CW-QS-45-0.375-SS-SI	CW-QS-45-0.375-AL-SI
		60°	CW-QS-60-0.375-CS-SI	CW-QS-60-0.375-SS-SI	CW-QS-60-0.375-AL-SI
		70°	CW-QS-70-0.375-CS-SI	CW-QS-70-0.375-SS-SI	CW-QS-70-0.375-AL-SI
0.5	12.7	45°	CW-QS-45-0.5-CS-SI	CW-QS-45-0.5-SS-SI	CW-QS-45-0.5-AL-SI
		60°	CW-QS-60-0.5-CS-SI	CW-QS-60-0.5-SS-SI	CW-QS-60-0.5-AL-SI
		70°	CW-QS-70-0.5-CS-SI	CW-QS-70-0.5-SS-SI	CW-QS-70-0.5-AL-SI

ELEMENT DIAMETER		0° DELAYS	
		ANGLE	PLEX
0.375	9.5	0°	CW-QS-0-0.375-1.00
			CW-QS-0-0.375-0.375
0.5	12.7	0°	CW-QS-0-0.5-1.00
			CW-QS-0-0.5-0.375

* See appendix for technical details (page 47)

QS - ANGLE BEAM

QS WEDGE DIMENSIONS

WEDGE TYPE	PART NUMBER	WEDGE DIMENSIONS					
		LENGTH	WIDTH	HEIGHT			
Carbon Steel	CW-QS-30-0.25-CS	0.70 in.	17.8 mm	0.45 in.	11.4 mm	0.37 in.	9.4 mm
Carbon Steel	CW-QS-45-0.25-CS	0.75 in.	19 mm	0.45 in.	11.4 mm	0.39 in.	9.9 mm
Carbon Steel	CW-QS-60-0.25-CS	0.84 in.	21.3 mm	0.45 in.	11.4 mm	0.44 in.	11.2 mm
Carbon Steel	CW-QS-70-0.25-CS	1.0 in.	25.4 mm	0.45 in.	11.4 mm	0.50 in.	12.7 mm
Carbon Steel	CW-QS-30-0.375-CS	0.83 in.	21.1 mm	0.55 in.	14 mm	0.47 in.	11.9 mm
Carbon Steel	CW-QS-45-0.375-CS	0.89 in.	22.6 mm	0.55 in.	14 mm	0.47 in.	11.9 mm
Carbon Steel	CW-QS-60-0.375-CS	1.04 in.	26.4 mm	0.55 in.	14 mm	0.55 in.	14 mm
Carbon Steel	CW-QS-70-0.375-CS	1.19 in.	30.2 mm	0.55 in.	14 mm	0.58 in.	14.7 mm
Carbon Steel	CW-QS-30-0.5-CS	0.98 in.	24.9 mm	0.70 in.	17.8 mm	0.55 in.	14 mm
Carbon Steel	CW-QS-45-0.5-CS	1.05 in.	26.7 mm	0.70 in.	17.8 mm	0.55 in.	14 mm
Carbon Steel	CW-QS-60-0.5-CS	1.24 in.	31.5 mm	0.70 in.	17.8 mm	0.64 in.	16.3 mm
Carbon Steel	CW-QS-70-0.5-CS	1.41 in.	35.8 mm	0.70 in.	17.8 mm	0.68 in.	17.3 mm

WEDGE TYPE	PART NUMBER	WEDGE DIMENSIONS					
		LENGTH	WIDTH	HEIGHT			
Stainless Steel	CW-QS-45-0.25-SS	0.75 in.	19 mm	0.45 in.	11.4 mm	0.43 in.	10.9 mm
Stainless Steel	CW-QS-60-0.25-SS	0.84 in.	21.3 mm	0.45 in.	11.4 mm	0.47 in.	11.9 mm
Stainless Steel	CW-QS-70-0.25-SS	1.0 in.	25.4 mm	0.45 in.	11.4 mm	0.52 in.	13.2 mm
Stainless Steel	CW-QS-45-0.375-SS	0.89 in.	22.6 mm	0.55 in.	14 mm	0.51 in.	13 mm
Stainless Steel	CW-QS-60-0.375-SS	1.04 in.	26.4 mm	0.55 in.	14 mm	0.56 in.	14.2 mm
Stainless Steel	CW-QS-70-0.375-SS	1.19 in.	30.2 mm	0.55 in.	14 mm	0.61 in.	15.5 mm
Stainless Steel	CW-QS-45-0.5-SS	1.05 in.	26.7 mm	0.70 in.	17.8 mm	0.63 in.	16 mm
Stainless Steel	CW-QS-60-0.5-SS	1.24 in.	31.5 mm	0.70 in.	17.8 mm	0.67 in.	17 mm
Stainless Steel	CW-QS-70-0.5-SS	1.41 in.	35.8 mm	0.70 in.	17.8 mm	0.71 in.	18 mm

WEDGE TYPE	PART NUMBER	WEDGE DIMENSIONS					
		LENGTH	WIDTH	HEIGHT			
Aluminum	CW-QS-45-0.25-AL	0.75 in.	19 mm	0.45 in.	11.4 mm	0.43 in.	10.9 mm
Aluminum	CW-QS-60-0.25-AL	0.84 in.	21.3 mm	0.45 in.	11.4 mm	0.47 in.	11.9 mm
Aluminum	CW-QS-70-0.25-AL	1.0 in.	25.4 mm	0.45 in.	11.4 mm	0.52 in.	13.2 mm
Aluminum	CW-QS-45-0.375-AL	0.89 in.	22.6 mm	0.55 in.	14 mm	0.51 in.	13 mm
Aluminum	CW-QS-45-0.5-AL	1.05 in.	26.7 mm	0.70 in.	17.8 mm	0.63 in.	16 mm
Aluminum	CW-QS-60-0.5-AL	1.24 in.	31.5 mm	0.70 in.	17.8 mm	0.67 in.	17 mm
Aluminum	CW-QS-70-0.5-AL	1.41 in.	35.8 mm	0.70 in.	17.8 mm	0.71 in.	18 mm

MATERIAL	PART NUMBER	WEDGE DIMENSIONS					
		LENGTH	WIDTH	HEIGHT			
Plex	CW-QS-0-0.375-1.00	0.87 in.	22.1 mm	0.87 in.	22.1 mm	1.1 in.	28 mm
Plex	CW-QS-0-0.375-0.375	0.87 in.	22.1 mm	0.87 in.	22.1 mm	0.48 in.	12.2 mm
Plex	CW-QS-0-0.5-1.00	0.87 in.	22.1 mm	0.87 in.	22.1 mm	0.48 in.	12.2 mm
Plex	CW-QS-0-0.5-0.375	0.87 in.	22.1 mm	0.87 in.	22.1 mm	1.1 in.	28 mm

WEDGE TYPE	PART NUMBER	WEDGE DIMENSIONS					
		LENGTH	WIDTH	HEIGHT			
Carbon Steel	CW-QS-45-0.25-CS-SI	0.62 in.	15.7 mm	0.45 in.	11.4 mm	0.39 in.	9.9 mm
Carbon Steel	CW-QS-60-0.25-CS-SI	0.75 in.	19 mm	0.45 in.	11.4 mm	0.45 in.	11.4 mm
Carbon Steel	CW-QS-70-0.25-CS-SI	0.80 in.	20.3 mm	0.45 in.	11.4 mm	0.50 in.	12.7 mm
Carbon Steel	CW-QS-45-0.375-CS-SI	0.78 in.	19.8 mm	0.55 in.	14 mm	0.47 in.	11.9 mm
Carbon Steel	CW-QS-60-0.375-CS-SI	0.85 in.	21.6 mm	0.55 in.	14 mm	0.55 in.	14 mm
Carbon Steel	CW-QS-70-0.375-CS-SI	0.97 in.	24.6 mm	0.55 in.	14 mm	0.57 in.	14.5 mm
Carbon Steel	CW-QS-45-0.5-CS-SI	0.90 in.	22.9 mm	0.70 in.	17.8 mm	0.55 in.	14 mm
Carbon Steel	CW-QS-60-0.5-CS-SI	1.06 in.	26.9 mm	0.70 in.	17.8 mm	0.64 in.	16.3 mm
Carbon Steel	CW-QS-70-0.5-CS-SI	1.17 in.	29.7 mm	0.70 in.	17.8 mm	0.70 in.	17.8 mm

WEDGE TYPE	PART NUMBER	WEDGE DIMENSIONS					
		LENGTH	WIDTH	HEIGHT			
Stainless Steel	CW-QS-45-0.25-SS-SI	0.62 in.	15.7 mm	0.45 in.	11.4 mm	0.39 in.	9.9 mm
Stainless Steel	CW-QS-60-0.25-SS-SI	0.75 in.	19 mm	0.45 in.	11.4 mm	0.47 in.	11.9 mm
Stainless Steel	CW-QS-70-0.25-SS-SI	0.80 in.	20.3 mm	0.45 in.	11.4 mm	0.50 in.	12.7 mm
Stainless Steel	CW-QS-45-0.375-SS-SI	0.78 in.	19.8 mm	0.55 in.	14 mm	0.47 in.	11.9 mm
Stainless Steel	CW-QS-60-0.375-SS-SI	0.85 in.	21.6 mm	0.55 in.	14 mm	0.55 in.	14 mm
Stainless Steel	CW-QS-70-0.375-SS-SI	1.02 in.	25.9 mm	0.55 in.	14 mm	0.59 in.	15 mm
Stainless Steel	CW-QS-45-0.5-SS-SI	0.90 in.	22.9 mm	0.70 in.	17.8 mm	0.55 in.	14 mm
Stainless Steel	CW-QS-60-0.5-SS-SI	1.06 in.	26.9 mm	0.70 in.	17.8 mm	0.64 in.	16.3 mm
Stainless Steel	CW-QS-70-0.5-SS-SI	1.17 in.	29.7 mm	0.70 in.	17.8 mm	0.67 in.	17 mm

WEDGE TYPE	PART NUMBER	WEDGE DIMENSIONS					
		LENGTH	WIDTH	HEIGHT			
Aluminum	CW-QS-45-0.25-AL-SI	0.62 in.	15.7 mm	0.45 in.	11.4 mm	0.39 in.	9.9 mm
Aluminum	CW-QS-60-0.25-AL-SI	0.75 in.	19 mm	0.45 in.	11.4 mm	0.47 in.	11.9 mm
Aluminum	CW-QS-70-0.25-AL-SI	0.80 in.	20.3 mm	0.45 in.	11.4 mm	0.50 in.	12.7 mm
Aluminum	CW-QS-30-0.375-AL-SI						
Aluminum	CW-QS-45-0.375-AL-SI	0.78 in.	19.8 mm	0.55 in.	14 mm	0.47 in.	11.9 mm
Aluminum	CW-QS-60-0.375-AL-SI	0.85 in.	21.6 mm	0.55 in.	14 mm	0.55 in.	14 mm
Aluminum	CW-QS-70-0.375-AL-SI	1.02 in.	25.9 mm	0.55 in.	14 mm	0.59 in.	15 mm
Aluminum	CW-QS-45-0.5-AL-SI	0.90 in.	22.9 mm	0.70 in.	17.8 mm	0.55 in.	14 mm
Aluminum	CW-QS-60-0.5-AL-SI	1.06 in.	26.9 mm	0.70 in.	17.8 mm	0.64 in.	16.3 mm
Aluminum	CW-QS-70-0.5-AL-SI	1.17 in.	29.7 mm	0.70 in.	17.8 mm	0.67 in.	17 mm

MSWS - ANGLE BEAM

Model MSWS have captive screws for wedge attachment and angled Microdot connectors for applications requiring low profile. Piezocomposite (C series*) offer superior penetration and signal-to-noise ratio in highly-attenuative and coarse-grain materials.

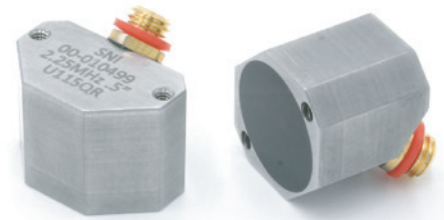

MSWS

DIAMETER	ELEMENT DIAMETER		PART NUMBER	ANGLE	WEDGES
1	0.5	12.7	MSWS-1.0-0.5-C-BNC	45°	CW-MSWS-45-0.5
				60°	CW-MSWS-60-0.5
2.25	0.25	6.4	MSWS-2.25-0.25-C-BNC	70°	CW-MSWS-70-0.5
				45°	CW-MSWS-45-0.25
				60°	CW-MSWS-60-0.25
2.25	0.5	12.7	MSWS-2.25-0.5-C-BNC	70°	CW-MSWS-70-0.25
				45°	CW-MSWS-45-0.5
				60°	CW-MSWS-60-0.5
3.5	0.25	6.4	MSWS-3.5-0.25-C-BNC	70°	CW-MSWS-70-0.5
				45°	CW-MSWS-45-0.25
				60°	CW-MSWS-60-0.25
3.5	0.5	12.7	MSWS-3.5-0.5-C-BNC	70°	CW-MSWS-70-0.5
				45°	CW-MSWS-45-0.5
				60°	CW-MSWS-60-0.5
5	0.25	6.4	MSWS-5.0-0.25-C-BNC	70°	CW-MSWS-70-0.5
				45°	CW-MSWS-45-0.25
				60°	CW-MSWS-60-0.25
5	0.5	12.7	MSWS-5.0-0.5-C-BNC	70°	CW-MSWS-70-0.5
				45°	CW-MSWS-45-0.5
				60°	CW-MSWS-60-0.5
10	0.25	6.4	MSWS-10.0-0.25-C-BNC	70°	CW-MSWS-70-0.5
				45°	CW-MSWS-45-0.25
				60°	CW-MSWS-60-0.25
10	0.5	12.7	MSWS-10.0-0.5-C-BNC	70°	CW-MSWS-70-0.5
				45°	CW-MSWS-45-0.5
				60°	CW-MSWS-60-0.5

| in. | mm |

DIMENSIONS

ELEMENT DIAMETER		A	B	C		D		Thread		
0.25	6.4	0.5	12	0.3	8.6	0.3	7.9	0.4	9.7	1-64
0.5	12.7	0.7	19	0.5	13	0.6	14	0.6	16	

| in. | mm | in. | mm | in. | mm | in. | mm |

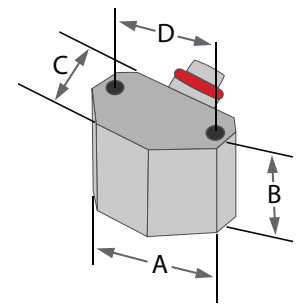

WEDGE DIMENSIONS

WEDGE TYPE	PART NUMBER	WEDGE DIMENSIONS					
		LENGTH		WIDTH		HEIGHT	
MSWS	CW-MSWS-45-0.25	0.59	15	0.5	12.7	0.26	6.6
MSWS	CW-MSWS-60-0.25	0.65	16.5	0.5	12.7	0.3	7.6
MSWS	CW-MSWS-70-0.25	0.73	18.5	0.5	12.7	0.33	8.4
MSWS	CW-MSWS-45-0.5	0.93	23.6	0.75	19	0.43	10.9
MSWS	CW-MSWS-60-0.5	1.05	26.7	0.75	19	0.5	12.7
MSWS	CW-MSWS-70-0.5	1.18	30	0.75	19	0.54	13.7

| in. | mm | in. | mm | in. | mm |

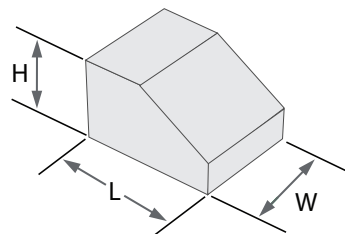

* See appendix for technical details (page 47)

AWS - ANGLE BEAM

Model AWS transducers and wedges meet the requirements of American Welding Society Structural Welding Code D1.1 and Bridge Welding Code D1.5. The transducers are available with piezoceramic elements (GP series*) and piezocomposite elements (C series*).



AWS

FREQUENCY	ELEMENT DIMENSIONS		PART NUMBER			
			GP	C	ANGLE	WEDGES
2.25	0.625 x 0.625	16 x 16	AWS-2.25-.625x.625-GP-BNC	AWS-2.25-.625x.625-C-BNC	45°	CW-AWS-45
					60°	CW-AWS-60
					70°	CW-AWS-79
	0.625 x 0.75	16 x 19	AWS-2.25-.625x.75-GP-BNC	AWS-2.25-.625x.75-C-BNC	45°	CW-AWS-45
					60°	CW-AWS-60
					70°	CW-AWS-79
	0.75 x 0.75	19 x 19	AWS-2.25-.75x75-GP-BNC	AWS-2.25-.75x75-C-BNC	45°	CW-AWS-45
					60°	CW-AWS-60
					70°	CW-AWS-79

| in. | mm |

DIMENSIONS

ELEMENT DIMENSIONS		A	B	C	D	THREAD
0.625 x 0.625	16 x 16	0.8 20.3	1.26 32	0.75 19.1	1 25.4	4-40
0.625 x 0.75	16 x 19	0.8 20.3	1.26 32	0.75 19.1	1 25.4	
0.75 x 0.75	19 x 19	0.85 21.6	1.26 32	0.75 19.1	1 25.4	

| in. | mm | in. | mm | in. | mm | in. | mm |

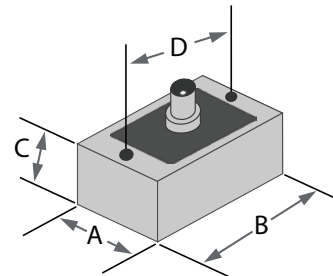

WEDGE DIMENSIONS

WEDGE TYPE	PART NUMBER	WEDGE DIMENSIONS					
		LENGTH		WIDTH		HEIGHT	
AWS	CW-AWS-45	1.82	46.2	1.25	31.8	1.91	48.5
AWS	CW-AWS-60	1.96	49.8	1.25	31.8	1.91	48.5
AWS	CW-AWS-79	2.17	55.1	1.25	31.8	2.16	54.9

| in. | mm | in. | mm | in. | mm |

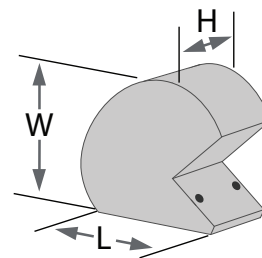

* See appendix for technical details (page 47)

SWS - ANGLE BEAM

Model SWS are designed for general weld inspection and other applications such as pipes, tanks, pressure vessels, forgings and castings. They have top mounted BNC connectors and are available with piezocomposite elements (C series*). Interchangeable acrylic wedges provide maximum versatility and service life.

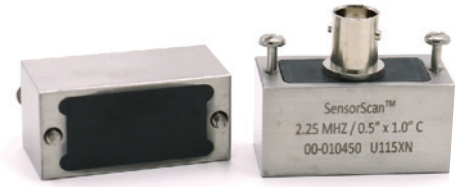

SWS

FREQUENCY	ELEMENT DIMENSIONS		PART NUMBERS		
			C	ANGLE	WEDGES
0.5	0.5 Ø	12.7 Ø	SWS-0.5-0.5-C-BNC	45°	CW-SWS-45-0.5
				60°	CW-SWS-60-0.5
				70°	CW-SWS-70-0.5
	0.5 x 1	12.7 x 25.4	SWS-0.5-0.5x1-C-BNC	45°	CW-SWS-45-.5X1.0
				60°	CW-SWS-60-.5X1.0
				70°	CW-SWS-70-.5X1.0
	0.75 x 1	19 x 25.4	SWS-0.5-0.75x1-C-BNC	45°	CW-SWS-45-.75X1.0
				60°	CW-SWS-60-.75X1.0
				70°	CW-SWS-70-.75X1.0
	1 Ø	25.4 Ø	SWS-0.5-1.0-C-BNC	45°	CW-SWS-45-1.0
				60°	CW-SWS-60-1.0
				70°	CW-SWS-70-1.0
1	0.5 Ø	12.7 Ø	SWS-1-0.5-C-BNC	45°	CW-SWS-45-0.5
				60°	CW-SWS-60-0.5
				70°	CW-SWS-70-0.5
	0.5 x 1	12.7 x 25.4	SWS-1-0.5x1-C-BNC	45°	CW-SWS-45-.5X1.0
				60°	CW-SWS-60-.5X1.0
				70°	CW-SWS-70-.5X1.0
	0.75 x 1	19 x 25.4	SWS-2.25-0.75x1-C-BNC	45°	CW-SWS-45-.75X1.0
				60°	CW-SWS-60-.75X1.0
				70°	CW-SWS-70-.75X1.0
	1 Ø	25.4 Ø	SWS-1-1.0-C-BNC	45°	CW-SWS-45-1.0
				60°	CW-SWS-60-1.0
				70°	CW-SWS-70-1.0

FREQUENCY	ELEMENT DIMENSIONS		PART NUMBERS		
			C	ANGLE	WEDGES
2.25	0.5 Ø	12.7 Ø	SWS-2.25-0.5-C-BNC	45°	CW-SWS-45-0.5
				60°	CW-SWS-60-0.5
				70°	CW-SWS-70-0.5
	0.5 x 1	12.7 x 25.4	SWS-2.25-0.5x1-C-BNC	45°	CW-SWS-45-.5X1.0
				60°	CW-SWS-60-.5X1.0
				70°	CW-SWS-70-.5X1.0
	0.75 x 1	19 x 25.4	SWS-2.25-0.75x1-C-BNC	45°	CW-SWS-45-.75X1.0
				60°	CW-SWS-60-.75X1.0
				70°	CW-SWS-70-.75X1.0
	1 Ø	25.4 Ø	SWS-2.25-1.0-C-BNC	45°	CW-SWS-45-1.0
				60°	CW-SWS-60-1.0
				70°	CW-SWS-70-1.0
3.5	0.5 Ø	12.7 Ø	SWS-3.5-0.5-C-BNC	45°	CW-SWS-45-0.5
				60°	CW-SWS-60-0.5
				70°	CW-SWS-70-0.5
	0.5 x 1	12.7 x 25.4	SWS-3.5-0.5x1-C-BNC	45°	CW-SWS-45-.5X1.0
				60°	CW-SWS-60-.5X1.0
				70°	CW-SWS-70-.5X1.0
	0.75 x 1	19 x 25.4	SWS-3.5-0.75x1-C-BNC	45°	CW-SWS-45-.75X1.0
				60°	CW-SWS-60-.75X1.0
				70°	CW-SWS-70-.75X1.0
	1 Ø	25.4 Ø	SWS-3.5-1.0-C-BNC	45°	CW-SWS-45-1.0
				60°	CW-SWS-60-1.0
				70°	CW-SWS-70-1.0
5	0.5 Ø	12.7 Ø	SWS-5.0-0.5-C-BNC	45°	CW-SWS-45-0.5
				60°	CW-SWS-60-0.5
				70°	CW-SWS-70-0.5
	0.5 x 1	12.7 x 25.4	SWS-5.0-0.5x1-C-BNC	45°	CW-SWS-45-.5X1.0
				60°	CW-SWS-60-.5X1.0
				70°	CW-SWS-70-.5X1.0
	0.75 x 1	19 x 25.4	SWS-5.0-0.75x1-C-BNC	45°	CW-SWS-45-.75X1.0
				60°	CW-SWS-60-.75X1.0
				70°	CW-SWS-70-.75X1.0
	1 Ø	25.4 Ø	SWS-5.0-1.0-C-BNC	45°	CW-SWS-45-1.0
				60°	CW-SWS-60-1.0
				70°	CW-SWS-70-1.0

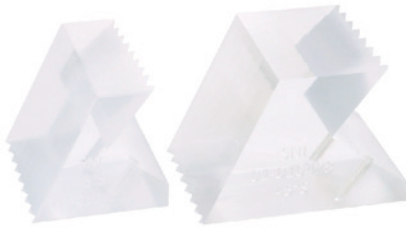

* See appendix for technical details (page 47)

SWS - ANGLE BEAM

DIMENSIONS

ELEMENT DIMENSIONS		A		B		C		D		THREAD
0.5 Ø	12.7 Ø	0.72	18.3	1	25.4	0.75	19	0.81	20.6	4-40
0.5 x 1	12.7 x 25.4	0.73	18.5	1.5	38.1	0.75	19	1.31	33.3	
0.75 x 1	19 x 25.4	1	25.4	1.5	38.1	0.75	19	1.31	33.3	
1 Ø	25.4 Ø	1.22	31	1.65	41.9	0.75	19	1.38	35.1	
<i>in.</i>	<i>mm</i>	<i>in.</i>	<i>mm</i>	<i>in.</i>	<i>mm</i>	<i>in.</i>	<i>mm</i>	<i>in.</i>	<i>mm</i>	

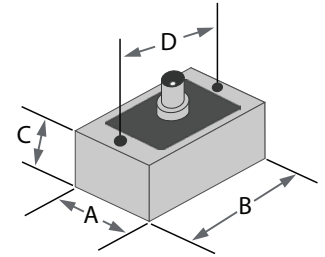

WEDGE DIMENSIONS

WEDGE TYPE	PART NUMBER	WEDGE DIMENSIONS					
		LENGTH		WIDTH		HEIGHT	
SWS	CW-SWS-45-0.5	1.35	34.3	1.1	30	1.3	33
SWS	CW-SWS-60-0.5	1.53	38.9	1.1	30	1.3	33
SWS	CW-SWS-70-0.5	1.82	46.2	1.1	30	1.3	33
SWS	CW-SWS-45-.5X1.0	1.35	34.3	1.6	40.6	1.3	33
SWS	CW-SWS-60-.5X1.0	1.53	38.9	1.6	40.6	1.3	33
SWS	CW-SWS-70-.5X1.0	1.82	46.2	1.6	40.6	1.3	33
SWS	CW-SWS-45-.75X1.0	2.1	53.3	1.5	38.1	1.5	38.1
SWS	CW-SWS-60-.75X1.0	2.3	48.4	1.5	38.1	1.5	38.1
SWS	CW-SWS-70-.75X1.0	2.59	65.8	1.5	38.1	1.5	38.1
SWS	CW-SWS-45-1.0	2.05	52.1	1.65	41.9	1.5	38.1
SWS	CW-SWS-60-1.0	2.24	56.9	1.65	41.9	1.5	38.1
SWS	CW-SWS-70-1.0	2.6	66	1.65	41.9	1.5	38.1
		<i>in.</i>	<i>mm</i>	<i>in.</i>	<i>mm</i>	<i>in.</i>	<i>mm</i>

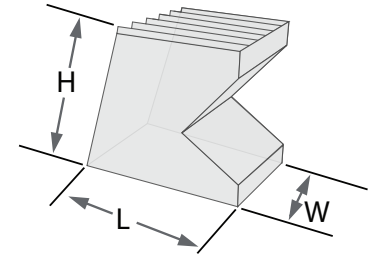

DHT SERIES - HIGH-TEMP DUAL

The DHT series of ultrasonic transducers are general-purpose probes for measuring the remaining wall thickness on rough metal ID and OD surfaces due to corrosion and/or erosion. These transducers can be used intermittently or continuously at various temperature ranges.

Typical applications include its use with common digital thickness gauges or flaw detectors on boiler/furnace tubes, pipes, tanks, vessels, structures, and other safety-critical components at power plants, refineries, mid- and up-stream oil and gas assets, and chemical facilities.



DHT

DHT-400	FREQUENCY	CONNECTOR	CONTINUOUS USE TEMP RANGE
DHT400-5-MD	5MHz	MD Connector	-17.8 to 204°C (0 to 400°F)
DHT400-5-MCX	5MHz	MCX Connector	-17.8 to 204°C (0 to 400°F)
DHT-410	FREQUENCY	CONNECTOR	CONTINUOUS USE TEMP RANGE
DHT410-5-MD	5MHz	MD Connector	-17.8 to 93°C (0 to 200°F)

CABLES

	CABLE OPTIONS				
	Lemo-00 Connector (Standard)	Probe Recognition Connector (Standard)	BNC Connector (Standard)	Lemo-00 Connector (Armored)	Probe Recognition Connector (Armored)
MD	Dual MD-M00Lemo-RG174-5	Dual MD-M00Lemo-RG174-5-Auto	Dual MD-MBNC-RG174-5	Dual MD-M00Lemo-RG174-5-AR	Dual MD-M00Lemo-RG174-5-Auto-AR
MCX	Dual MCX-M00Lemo-RG174-5	Dual MCX-M00Lemo-RG174-5-Auto	Dual MCX-MBNC-RG174-5	Dual MCX-M00Lemo-RG174-5-AR	Dual MCX-M00Lemo-RG174-5-Auto-AR

DHT SERIES - HIGH-TEMP DUAL



ACCESSORIES

COOL HAND	EXTENSION HANDLE
DHT400-Cool Hand	DHT400-Extension Handle

DIMENSIONS

DHT-400

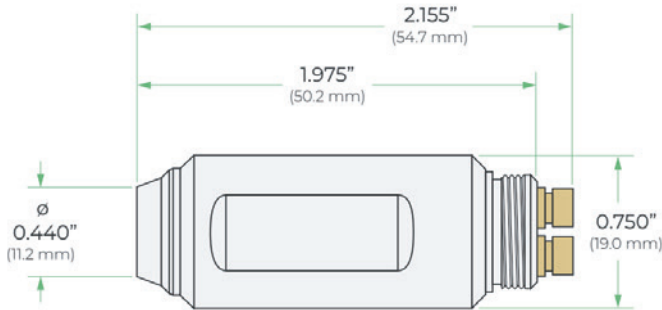

DHT-410

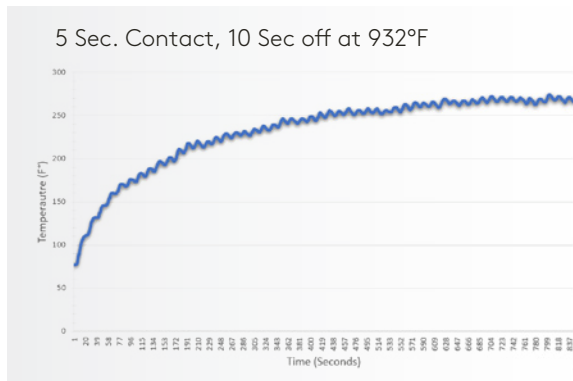
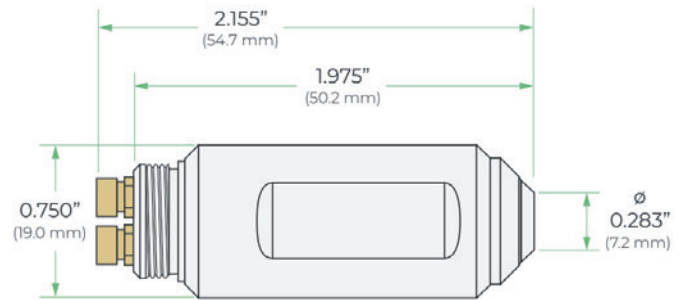

- ▲ This chart shows a 33% duty cycle at 5 seconds on and 10 seconds off. The DHT-400 plateaus at ~270°F which keeps the sensitive elements from ever reaching 400°F.

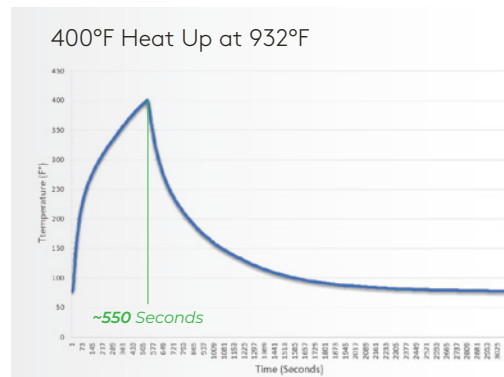

- ▲ At 932°F continuous surface contact temp, it takes over 9 minutes for the sensitive solder joints within the transducer to get to a 400°F.

ADP - DUAL ELEMENT

Model ADP are small-diameter, low-profile transducers especially suitable for flaw detection and thickness measurement on pitted, curved, and irregular surfaces. Because the elements are mounted on internal delay lines they can be contoured to fit I.D. or O.D. curved surfaces. All ADPs are C series* which has piezocomposite elements and offer superior penetration, resolution and signal-to-noise ratio in highly attenuative and coarse grain materials. Potted BNC and Lemo-00 versions are available along with a MD non-potted version. Please note, cables are not included with the MD versions. Refer to page XX for cable options.



ADP

FREQUENCY	ELEMENT DIAMETER		PART NUMBER (CABLE OPTION)		
			Potted BNC	Potted Lemo-00	MD
2.25	0.25	6.4	ADP-2.25-.25-BNC	ADP-2.25-.25-LEMO	ADP-2.25-.25-MD
	0.375	9.5	ADP-2.25-.375-BNC	ADP-2.25-.375-LEMO	ADP-2.25-.375-MD
	0.5	12.7	ADP-2.25-.5-BNC	ADP-2.25-.5-LEMO	ADP-2.25-.5-MD
3.5	0.25	6.4	ADP-3.5-.25-BNC	ADP-3.5-.25-LEMO	ADP-3.5-.25-MD
	0.375	9.5	ADP-3.5-.375-BNC	ADP-3.5-.375-LEMO	ADP-3.5-.375-MD
	0.5	12.7	ADP-3.5-.5-BNC	ADP-3.5-.5-LEMO	ADP-3.5-.5-MD
5	0.25	6.4	ADP-5-.25-BNC	ADP-5-.25-LEMO	ADP-5-.25-MD
	0.375	9.5	ADP-5-.375-BNC	ADP-5-.375-LEMO	ADP-5-.375-MD
	0.5	12.7	ADP-5-.5-BNC	ADP-5-.5-LEMO	ADP-5-.5-MD
10	0.25	6.4	ADP-10-.25-BNC	ADP-10-.25-LEMO	ADP-10-.25-MD
	0.375	9.5	ADP-10-.375-BNC	ADP-10-.375-LEMO	ADP-10-.375-MD
	0.5	12.7	ADP-10-.5-BNC	ADP-10-.5-LEMO	ADP-10-.5-MD

DIMENSIONS

ELEMENT DIMENSIONS		A		B		C	
0.25	6.4	0.5	12.7	0.64	16.3	0.28	7.1
0.375	9.5	0.62	15.7	0.64	16.3	0.41	10.4
0.5	12.7	0.75	19	0.68	17.3	0.6	15.2
<i>in.</i>	<i>mm</i>	<i>in.</i>	<i>mm</i>	<i>in.</i>	<i>mm</i>	<i>in.</i>	<i>mm</i>

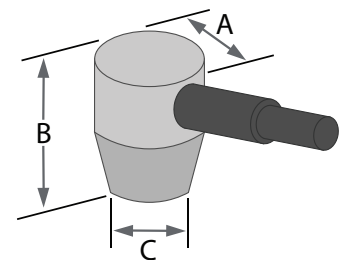

* See appendix for technical details (page 47)

THICKNESS GAUGING PROBES

PRECISION (SINGLE ELEMENT)

For use with commercial thickness gauges and flaw detection instruments.

MODEL	NOMINAL FREQUENCY	TRANSDUCER TYPE	CONTACT DIAMETER		MEASURING RANGE IN STEEL	PART NUMBER
Alpha2 DFR +	15 MHz	Delay Line Removable	0.3	7.6	0.007 to 1 inch 0.18 to 25.4 mm	Alfa2-DFR-15-0.25-MD
CA211 +	5 MHz	Standard Contact	0.75	19	0.60 to 20 inch 1.5 to 508 mm	CA211-C-5-0.5-MD
Alpha2 F +	10 MHz	Small Contact	0.375	9.7	0.60 to 10 inch 1.5 to 254 mm	Alfa2-F-10-0.25-MD
Alpha2 Mini DFR +	20 MHz	Thin Range Delay Line	0.19	4.8	0.005 to 0.2 inch 0.13 to 5.1 mm	MiniDFR-20-0.19-MD

00-010415
CA211 +



CORROSION (DUAL ELEMENT)

For use with commercial corrosion thickness gauges and flaw detection instruments.

MODEL	NOMINAL FREQUENCY	TRANSDUCER TYPE	CONTACT DIAMETER		MEASURING RANGE IN STEEL*	PART NUMBER
FH2E +	7.5 MHz	Fingertip	0.375	9.7	0.030 to 2.0 inch 0.76 to 50.8 mm	FH2E-F-0.375-7.5-DM-4
FH2E + RA	7.5 MHz	Fingertip Right Angle	0.375	9.7	0.030 to 2.0 inch 0.76 to 50.8 mm	FH2E-F-0.375-7.5-DM-4-RA
FH2E + LEMO-00	7.5 MHz	Fingertip Lemo-00	0.375	9.7	0.030 to 2.0 inch 0.76 to 50.8 mm	FH2E-F-0.375-7.5-L-4
FH2E + TM	7.5 MHz	Fingertip	0.375	9.7	0.030 to 2.0 inch 0.76 to 50.8 mm	FH2E-F-0.375-7.5-DM-4-TM
FH2E + WR	7.5 MHz	Fingertip Wear Resistant	0.55	14	0.030 to 2.0 inch 0.76 to 50.8 mm	FH2E-WR-0.55-7.5-DM-4
FH2E + MD	7.5 MHz	Fingertip	0.375	9.7	0.030 to 2.0 inch 0.76 to 50.8 mm	FH2E-F-0.375-7.5-MD
FH2E + M	7.5 MHz	Fingertip Small Diameter	0.28	7.1	0.030 to 1.0 inch 0.76 to 25.4 mm	FH2E-M-0.28-7.5-DM-4
FH2E + with BNC	7.5 MHz	Fingertip	0.375	9.7	0.030 to 2.0 inch 0.76 to 50.8 mm	FH2E-F-0.375-7.5-BNC-6
FH2E + BT	7.5 MHz	Studded Boiler Tube	0.375	9.7	0.060 to 2.0 inch 1.5 to 50.8 mm	FH2E-BT-0.375-7.5-DM-4
DA 512 +	7.5 MHz	Fingertip	0.295	7.5	0.024 to 2.4 inch 0.6 to 61 mm	DA512-F-0.295-7.5-DM-4

00-010424
FH2E +



00-013934
FH2E + TM



* The measurement range is dependent on the part's material type, geometry, surface condition, and temperature. Another consideration is proper selection of couplant.

THICKNESS GAUGING PROBES

Alpha2 DFR +

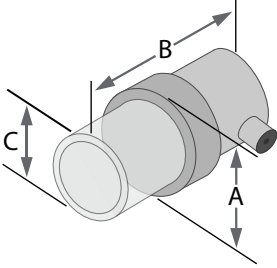

CA211 +

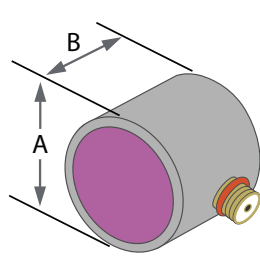

Alpha2 F +

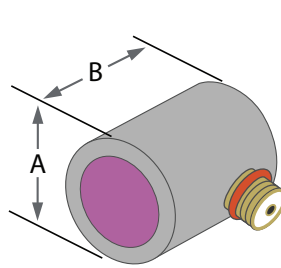

Alpha2 Mini DFR +

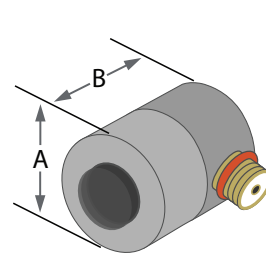

FH2E +

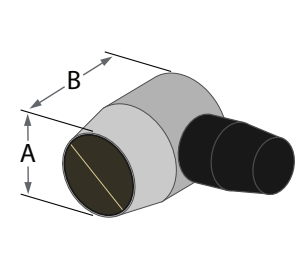

FH2E + RA

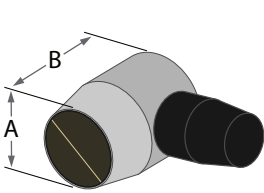

FH2E + LEMO-00

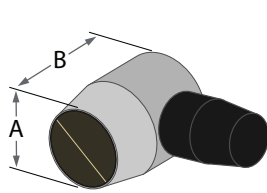

FH2E + TM

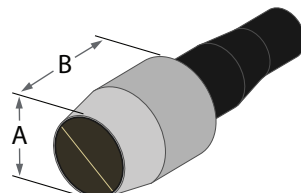

FH2E + WR

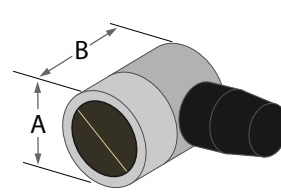

FH2E + MD

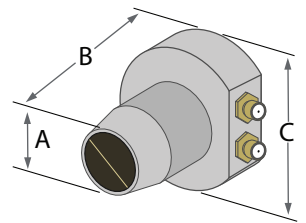

FH2E + M

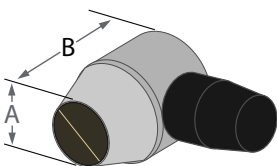

FH2E + w/BNC

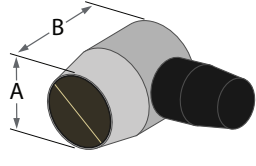

FH2E + BT

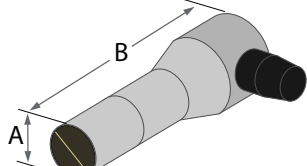

DA 512 +

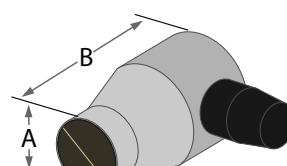

CASE TYPE	CASE DIMENSIONS					
	A		B		C	
Alpha2 DFR +	0.51 in.	13 mm	0.83 in.	21.1 mm	0.3 in.	7.6 mm
CA211 +	0.75 in.	19.1 mm	0.65	16.5 mm		
Alpha2 F +	0.5 in.	12.7 mm	0.65	16.5 mm		
Alpha2 Mini DFR +	0.4 in.	10.2 mm	0.46 in.	11.7 mm		
FH2E +	0.38 in.	9.7 mm	0.73 in.	18.5 mm		
FH2E + RA	0.38 in.	9.7 mm	0.73 in.	18.5 mm		
FH2E + LEMO-00	0.38 in.	9.7 mm	0.73 in.	18.5 mm		
FH2E + TM	0.38 in.	9.7 mm	0.93 in.	23.6 mm		

CASE TYPE	CASE DIMENSIONS					
	A		B		C	
FH2E + WR	0.54 in.	13.7 mm	0.73 in.	18.5 mm		
FH2E + MD	0.38 in.	9.7 mm	1.04 in.	26.4 mm	1.0 in.	25.4 mm
FH2E + M	0.28 in.	7.1 mm	0.725 in.	18.4 mm		
FH2E + w/BNC	0.38 in.	9.7 mm	0.73 in.	18.5 mm		
FH2E + BT	0.38 in.	9.7 mm	2.0 in.	50.8 mm		
DA 512 +	0.29 in.	7.4 mm	0.67 in.	17 mm		

12, 13, 14 - IMMERSION

All model I2, I3 and I4 transducers have straight-mounted waterproof UHF connectors. Available I2 element diameters are 0.25, 0.375 and 0.5 inch (6, 10 and 13 mm). I3 have 0.75 inch (19 mm) and I4 have 1.0 inch (25 mm) element diameters. GP series* offer the best combination of sensitivity and resolution for general applications. HR series* are highly-damped for applications where high resolution is required. C series* have piezocomposite elements and offer superior penetration, resolution and signal-to-noise ratio in highly-attenuative and coarse-grain materials.



Please choose your Part number from the following charts based on Case Type, Transducer Frequency and Element Diameter. The Part Number on the charts specifies these attributes.

To Specify the Focal Length (in inches) and Focal Type (Spherical or Cylindrical) you desire: Edit the X.X S and Y.YC suffixes shown in the chart to match your requirements.

(ex. The suffix for a 2.0" Spherical focus is changed from X.XS to 2.0S; The suffix for a 3.0" Cylindrical Focus is changed from Y.YC to 3.0C)

NF = Non-focused (flat)
S = Spherical focus
C = Cylindrical focus

12, 13, 14

FREQUENCY	ELEMENT DIAMETER		CASE	FOCUS	PART NUMBER		
					GP	HR	C
1	0.5	12.7	I2	Spherical			I-I2-1.0-.50-CHR-UHF-NF
				None	I-I3-1.0-.75-GP-UHF-NF		I-I3-1.0-.75-C-UHF-NF
	0.75	19	I3	Spherical			I-I3-1.0-.75-C-UHF-1.5S
				Cylindrical			I-I3-1.0-.75-C-UHF-1.5C
	1	25.4	I4	None			I-I4-1.0-1.0-C-UHF-NF
2.25	0.25	6.4	I2	None	I-I2-2.25-.25-GP-UHF-NF	I-I2-2.25-.25-HR-UHF-NF	
				Spherical	I-I2-2.25-.25-GP-UHF-0.375S		
	0.375	9.5	I2	None	I-I2-2.25-.375-GP-UHF-NF		
				Spherical			I-I2-2.25-.50-HR-UHF-2.0S
	0.5	12.7	I2	None	I-I2-2.25-.50-GP-UHF-NF	I-I2-2.25-.50-HR-UHF-NF	I-I2-2.25-.50-C-UHF-NF
				Spherical	I-I2-2.25-.50-GP-UHF-1.5S		
	0.75	19	I3	None	I-I3-2.25-.75-GP-UHF-NF	I-I3-2.25-.75-HR-UHF-NF	
				Spherical	I-I3-2.25-.75-GP-UHF-3.0S	I-I3-2.25-.75-HR-UHF-3.5S	I-I3-2.25-.75-C-UHF-4.5S
				Cylindrical			I-I3-2.25-.75-C-UHF-1.5C
				None	I-I4-2.25-1.0-GP-UHF-NF		I-I4-2.25-1.0-C-UHF-NF
			Spherical		I-I4-2.25-1.0-HR-UHF-6.0S	I-I4-2.5-1.0-C-UHF-6.0S	
3.5	0.375	9.5	I2	None			I-I2-2.25-.375-CHR-NF-UHF
				Spherical		I-I2-3.5-.375-HR-UHF-1.0S	
	0.5	12.7	I2	None			I-I2-3.5-.50-CHR-UHF-NF
				None			I-I3-3.5-.75-C-UHF-NF
	0.75	19	I3	Spherical	I-I3-3.5-.75-GP-UHF-3.0S	I-I3-3.5-.75-HR-UHF-3.0S	I-I3-3.5-.75-C-UHF-3.0S
				Spherical		I-I4-3.5-1.0-HR-UHF-4.0S	I-I4-3.5-1.0-C-UHF-11.0S
	1	25.4	I4	Cylindrical			I-I4-3.5-1.0-C-UHF-5.0C

* See appendix for technical details (page 47)

12, 13, 14 - IMMERSION

12, 13, 14

FREQUENCY	ELEMENT DIAMETER		CASE	FOCUS	PART NUMBER			
					GP	HR	C	
5	0.25	6.4	12	None	I-12-5.0-.25-GP-UHF-NF	I-12-5.0-.25-HR-UHF-NF	I-12-5.0-.25-C-UHF-NF	
				Spherical	I-12-5.0-.25-GP-UHF-0.75S			
	0.375	9.5	12	None	I-12-5.0-.375-GP-UHF-NF	I-12-5.0-.375-HR-UHF-NF	I-12-5.0-.375-CHR-UHF-NF	
				Spherical	I-12-5.0-.375-HR-UHF-2.5S			
	0.5	12.7	12	None	I-12-5.0-.50-GP-UHF-NF	I-12-5.0-.50-HR-UHF-NF	I-12-5.0-.50-CHR-UHF-NF	
				Spherical	I-12-5.0-.50-GP-UHF-3.5S			
	0.75	19	13	Cylindrical	I-12-5.0-.50-GP-UHF-1.5C	I-12-5.0-.50-HR-UHF-2.0C	I-12-5.0-.50-C-UHF-3.25C	
				None	I-13-5.0-.75-GP-UHF-NF	I-13-5.0-.75-HR-UHF-NF	I-13-5.0-.75-CHR-UHF-NF	
	1	25.4	14	Spherical	I-13-5.0-.75-GP-UHF-6.0S			
				Cylindrical	I-13-5.0-.75-GP-UHF-6.0C			
	12 Nominal	0.5	12.7	None	I-14-5.0-1.0-GP-UHF-NF			
				Spherical	I-14-5.0-1.0-C-UHF-5.25S			
10	0.25	6.4	12	Cylindrical	I-14-5.0-1.0-CHR-UHF-8.0C			
				None	I-12-10.0-.25-GP-UHF-NF	I-12-10.0-.25-HR-UHF-NF	I-12-10.0-.25-C-UHF-NF	
	0.375	9.5	12	Spherical	I-12-10.0-.25-GP-UHF-1.0S	I-12-10.0-.25-HR-UHF-1.5S		
				Cylindrical	I-12-10.0-.25-GP-UHF-1.5C			
	0.5	12.7	12	None	I-12-10-.375-GP-UHF-NF	I-12-10-.375-HR-UHF-NF		
				Spherical	I-12-10-.375-HR-UHF-3.0S			
	0.75	19	13	Cylindrical	I-12-10-.375-HR-UHF-3.0C			
				None	I-12-10.0-.50-GP-UHF-NF	I-12-10.0-.50-HR-UHF-NF	I-12-10.0-.50-C-UHF-NF	
	1	25.4	14	Spherical	I-12-10.0-.50-GP-UHF-6.0S			
				Cylindrical	I-12-10.0-.50-GP-UHF-2.5C			
	15	0.375	9.5	12	None	I-13-10-.75-GP--UHF-NF	I-13-10-.75-HR-UHF-NF	
					Spherical	I-13-10-.75-HR-UHF-6.0S		
15	0.5	12.7	12	Cylindrical	I-13-10-.75-C-UHF-8.0S			
				None	I-13-10-.75-GP-UHF-6.0C	I-13-10-.75-HR-UHF-6.0C		
15	0.5	12.7	12	Spherical	I-13-10-.75-C-UHF-8.0S			
				Spherical	I-14-10-1.0-C-UHF-6.0S			
15	0.5	12.7	12	Spherical	I-12-12 Nom--.50-HR-UHF-6.0S			
				Spherical	I-12-15-.25-HR-UHF-NF			
15	0.375	9.5	12	Spherical	I-12-15-.25-HR-UHF-1.5S			
				Cylindrical	I-12-15.0-.375-HR-UHF-2.0S			
15	0.5	12.7	12	None	I-12-15-.375-HR-UHF-5.0C			
				Spherical	I-12-15MHz-.50-HR-UHF-NF			
15	0.5	12.7	12	Spherical	I-12-15-.50-HR-UHF-2.0S			

DIMENSIONS

	ELEMENT DIAMETER			
	INCH	0.25	0.375	0.5
	MM	6.4	9.5	12.7
A		0.63 in. 16 mm	0.63 in. 16 mm	0.63 in. 16 mm
B		1.4 in.	1.4 in.	1.4 in.
C		18.5 mm	18.5 mm	18.5 mm
D		1.55 in.	1.55 in.	1.55 in.
E		5/8 - 24 UNEF		

	ELEMENT DIAMETER	
	INCH	0.75
	MM	19
A		1.0 in. 25.4 mm
B		1.3 in.

	ELEMENT DIAMETER	
	INCH	1
	MM	25.4
A		1.25 in. 31.8 mm
B		1.35 in.

IR - IMMERSION

Immersion Transducers are typically used in automatic and manual scanning systems using water or other liquid as a coupling medium to enable the inspection of parts with complex geometries and near-surface resolution superior to that of contact transducers. Spherical (point) or cylindrical (line) focusing can further improve sensitivity and resolution. Focal length and focal type must be specified. GP series* offer the best combination of sensitivity and resolution for general applications. HR series* are highly-damped for applications where high resolution is required. C series* have piezocomposite elements and offer superior penetration, resolution and signal-to-noise ratio in highly-attenuative and coarse-grain materials.

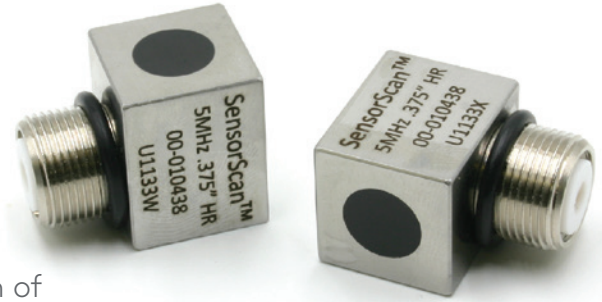

IR

FREQUENCY	ELEMENT DIAMETER		FOCUS	PART NUMBER		
				GP	HR	C
1	0.5	12.7	Cylindrical		I-IR-10.0-.50-HR-UHF-X.XC	
2.25	0.375	9.5	None	I-IR-2.25-.375-GP-UHF-NF	I-IR-2.25-.375-HR-UHF-NF	I-IR-2.25-.375-C-UHF-NF
			Cylindrical			I-IR-2.25-.375-C-UHF-NF
5	0.25	6.4	None	I-IR-5.0-.25-GP-UHF-NF		
	0.375	9.5	None	I-IR-5.0-.375-GP-UHF-NF	I-IR-5.0-.375-HR-UHF-NF	I-IR-5.0-.375-C-UHF-NF
	0.5	12.7	None	I-IR-5.0-.50-GP-UHF-NF		
10	0.5	12.7	Cylindrical		I-IR-5.0-.50-HR-UHF-X.XC	
			Cylindrical		I-IR-10.0-.50-HR-UHF-X.XC	

DIMENSIONS

ELEMENT DIAMETER		A	B		C		D	
0.25	6.4	5/8 - 24 UNEF	0.75	19	0.75	19	0.94	23.9
0.375	9.5	5/8 - 24 UNEF	0.75	19	0.75	19	0.94	23.9
0.5	12.7	5/8 - 24 UNEF	0.75	19	0.75	19	0.94	23.9
in.	mm		in.	mm	in.	mm	in.	mm

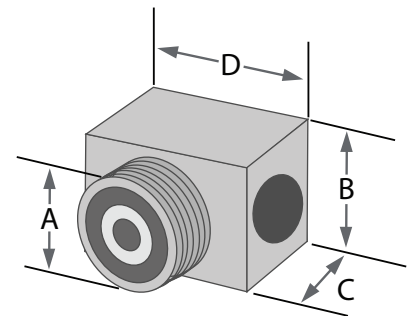

* See appendix for technical details (page 47)

I1 - IMMERSION

Model I1 are small-diameter, pencil-type transducers with straight-mounted Microdot connectors. Because the connectors are not waterproof, sealing with non-water-soluble grease is recommended. GP series* offer the best combination of sensitivity and resolution for general applications. HR series* are highly damped for applications where high resolution is required. C series* have piezocomposite elements and offer superior penetration, resolution and signal-to-noise ratio in highly-attenuative and coarse-grain materials.



I1

FREQUENCY	ELEMENT DIAMETER		FOCUS	PART NUMBER		
				GP	HR	C
5	0.25	6.4	None	I-I1-5.0-.25-GP-MD-NF	I-I1-5.0-.25-HR-MD-NF	
			Spherical		I-I1-5.0-.25-HR-MD-X.XS	
10	0.25	6.4	None	I-I1-10-.25-GP-MD-NF	I-I1-10.0-.25-HR-MD-NF	I-I1-10-.25-C-MD-NF
			Spherical	I-I1-10-.25-GP-MD-X.XS	I-I1-10.0-.25-HR-MD-X.XS	I-I1-10-.25-C-MD-X.XS
			Cylindrical	I-I1-10-.25-GP-MD-X.XC	I-I1-10.0-.25-HR-MD-X.XC	I-I1-10-.25-CHR-MD-X.XC
15	0.25	6.4	None		I-I1-15.0-.25-HR-MD-NF	
			Spherical		I-I1-15.0-.25-HR-MD-X.XS	I-I1-15-.25-C-MD-X.XS

DIMENSIONS

ELEMENT DIAMETER		A		B	
0.25	6.4	0.38	9.7	1.25	31.8
in.	mm	in.	mm	in.	mm

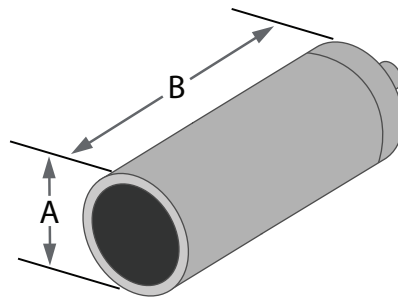

* See appendix for technical details (page 47)

CONVENTIONAL ACCESSORIES

CABLES

CABLE	MATERIAL	LENGTH	PART NUMBER
BNC - BNC	RG58	6-ft (1.83 m)	MBNC-MBNC-RG58-6
BNC - MD	RG174 TPR	6-ft (1.83 m)	MBNC-MD-RG174-6
BNC - MCX	RG174 TPR	6-ft (1.83 m)	MBNC-MCX-RG174-6
BNC - 00-Lemo	RG174 TPR	6-ft (1.83 m)	MBNC-00Lemo-RG174-6
00-Lemo - MD	RG174 TPR	6-ft (1.83 m)	00Lemo-MD-RG174-6
00-Lemo - 00-Lemo	RG174 TPR	6-ft (1.83 m)	M00Lemo-M00Lemo-RG174-6

CABLE	MATERIAL	LENGTH	PART NUMBER
00-Lemo - MCX	RG174 TPR	6-ft (1.83 m)	M00Lemo-MCX-RG174-6
BNC - MCX (RA)	RG174 TPR	6-ft (1.83 m)	MBNC-MCX (RA)-RG174-6
Dual BNC - Dual MD	RG174 TPR	6-ft (1.83 m)	Dual MBNC-Dual MD-RG174-6
Dual 00-Lemo - Dual MD	RG174 TPR	6-ft (1.83 m)	Dual00Lemo-Dual MD-RG174-6
Lemo 1 - MD	RG174 TPR	6-ft (1.83 m)	Lemo1-MD-RG174-6
Lemo 1 - BNC	RG174 TPR	6-ft (1.83 m)	Lemo1-MBNC-RG174-6

CONVENTIONAL ADAPTERS

ADAPTERS	PART NUMBER
BNC Female to Female RF Adaptor	FBNC-FBNC-Adapter
Male Lemo-00 to Female BNC Adapter	M00Lemo-FBNC-Adapter
Female Lemo-00 to Male BNC Adapter	F00Lemo-MBNC-Adapter
Male BNC to Female Right Angle BNC Adapter	MBNC-FBNCRA-Adapter
Female BNC to Male Lemo-00 Adapter	FBNC-M00Lemo-Adapter

CABLE CONNECTORS

MICRODOT 

BNC 

LEMO-00 

LEMO 1 

MCX* 

RIGHT-ANGLE MCX* 

*MCX connectors are snap-in and can swivel, preventing the risk of back threading.

WEDGE CURVATURE TERMINOLOGY

Axial OD



Axial ID



Skew - Base Metal



Circumferential OD



Circumferential ID

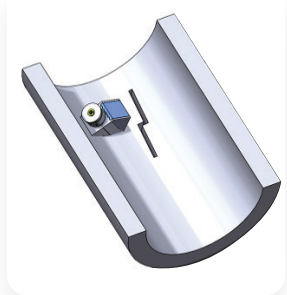

Skew - Fillet Weld

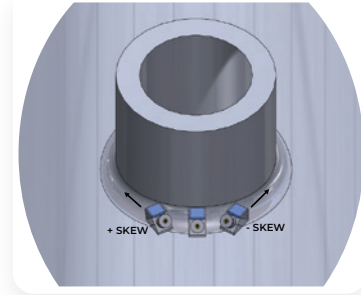

PROBE SERIES TECHNICAL INFORMATION

High Resolution Series

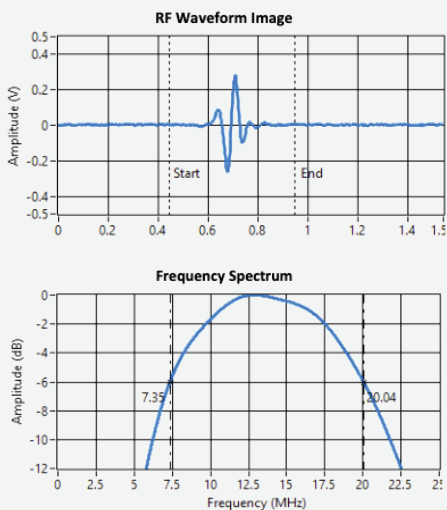

HR: High Resolution Series of transducers are highly damped and recommended for applications where enhanced axial and near-surface resolution are more important. Generally includes thickness measurement and near-surface flaw detection. HR series have less sensitivity than the GP or C series with -6db frequency bandwidth of 50-100% range.

General Purpose Series

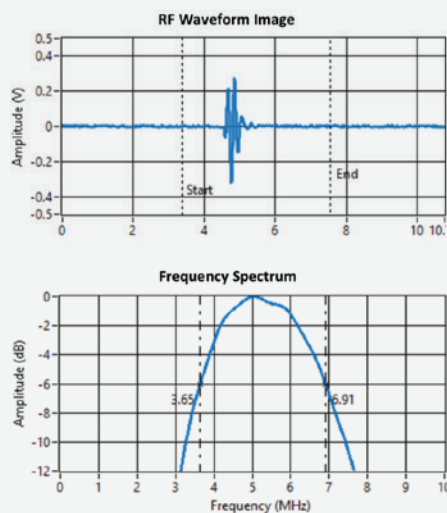

GP: General Purpose Series of transducers are recommended for most applications and have a good trade-off between sensitivity and resolution. They have a medium frequency bandwidth of 40-65% at -6db but with more ring-down cycles in the waveform.

Composite or Piezo-composite Series

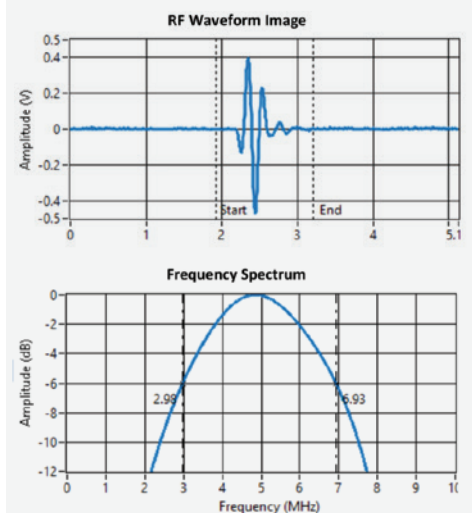

C: Composite (Piezo-composite) Series of transducers have superior sensitivity and penetration especially in highly-attenuative materials. C Series have both higher resolution, sensitivity, and have wide bandwidth (60-120% at -6db) due to the lower acoustic impedance of the material. They couple more efficiently into plastic wedges, delay lines, and water.

CUSTOM SOLUTIONS FOR ALL YOUR INSPECTION CHALLENGES

Eddyfi Technologies has invested in people, technology, and infrastructure to create a vertically integrated process for the design and manufacturing of inspection systems. In-house CAD/CAM capabilities, including full-scale machine shop operation with 5-axis CNC mills and lathes, allow for rapid prototyping of complex geometries and materials. In-house ceramic fabrication facilities enable fast and efficient turnaround for critical piezo-composite materials. With a team of highly experienced applications engineers, our custom applications lab has the best minds working to create the best solutions for all your most critical inspection challenges.

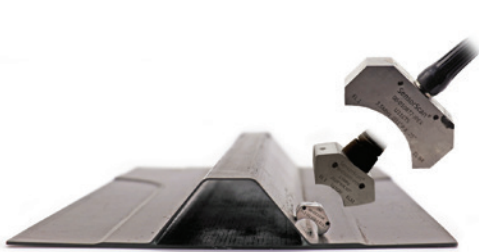

Curved immersion arrays for the inspection of carbon-fiber-reinforced polymers corners



Custom 256-element array for aerospace forging inspection



Custom 92-element array for tube and bar testing machines



INDUSTRY-LEADING DESIGN AND SIMULATION PROCESSES

UltraVision 3D: NDT data imaging and analysis software

SolidWorks: Parametric 3D CAD and mechanical properties modeling

AutoCAD: 2D CAD and ray-tracing

CIVA: Acoustic beam modeling and delay-law calculation

PiezoCAD: Transducer construction and performance modeling

Field II: Transducer construction and performance modeling

ES Beam Tool: Ultrasonic inspection plan design and validation software



ONE-STOP PAUT SHOP

Eddyfi Technologies, renowned for its commitment to excellence in non-destructive testing, is now your trusted partner for all PAUT needs, offering a holistic solution that covers everything from state-of-the-art probes to advanced data acquisition and analysis units, as well as scanners. With decades of experience, we stand at the forefront of NDT technology, and our inspection solutions are designed by experts, for experts, ensuring the highest quality and reliability for your inspections.

Our expanded PAUT offering has been designed to streamline your inspection process, enhancing efficiency and cost-effectiveness. At Eddyfi, we take pride in our commitment to meeting strict regulatory standards and codes, making us the preferred choice in industries with rigorous safety and quality requirements.

Key Highlights of Eddyfi Technologies' Expanded PAUT Offering

- **Comprehensive Solutions:** Our complete PAUT package is tailored to meet your unique inspection challenges. Whether you require generic standard probes or application-specific solutions, we have you covered.
- **Training and Support:** Beyond equipment, Eddyfi Technologies provides training and support services to ensure you have the knowledge and assistance you need to maximize the potential of your NDT capabilities. Visit the [Eddyfi Academy](#).
- **Accessibility and Efficiency:** We understand the challenges faced by industry professionals when sourcing PAUT equipment. In the past, procuring PAUT probes from third parties often came with hefty price tags and long lead times. With our readily available, on-the-shelf stocked items, we aim to streamline your inspection process, ensuring you have what you need when you need it. Check out the [Eddyfi eStore](#).
- **Custom Solutions:** For those with unique requirements, we offer custom-designed application-specific probes to address specific challenges.
- **Reduced Lead Times and Costs:** Our unwavering focus is on reducing lead times and costs, making our PAUT solutions both accessible and cost-effective.

Eddyfi Technologies recognizes the complexity and demands of the industry and strives to provide more than just equipment – **we are the solution provider for the complete PAUT package**. Our commitment to customer success goes beyond providing tools; we offer guidance and training, ensuring you have the resources needed for success.

"I can confidently say that our integration with Sensor Networks, Inc. has transformed us into the go-to destination for comprehensive phased array ultrasonic testing solutions. Our commitment to quality, efficiency, and customer success is unparalleled. We're not just providing inspection equipment; we're offering expertise, support, and a game-changing approach to NDT."

Frédéric Laprise, VP, Center of Excellence - PAUT

Eddyfi Technologies is dedicated to making PAUT solutions accessible, efficient, and cost-effective, and we are confident that our expanded offering will revolutionize the way you approach non-destructive testing.



The information in this document is accurate as of its publication. Actual products may differ from those presented herein.

©2024 Eddyfi Canada Inc. Eddyfi & WheelArray and their associated logos are trademarks or registered trademarks of Eddyfi Canada Inc. in Canada and/or other countries. Eddyfi Technologies reserves the right to change product offerings and specifications without notice. Eddyfi Technologies is a Previa Business Unit

2024-7-12

www.eddyfi.com

info@eddyfi.com

